



CM70122Rev3



# Table of Contents

A. General Information .....	5
1. Product Description, Features and Benefits .....	5
Features and benefits.....	5
Product range.....	5
2. Product Scope of Use .....	5
3. Product Limitations .....	6
4. BCA& NZBC Relevant Performance Clauses .....	6
Structural performance - Clause B1 .....	6
Durability - Clause B2 .....	6
External Moisture - Clause E2 .....	6
Hazardous Building Materials -Clause F2 .....	6
NCC – National Construction Code, Building Code of Australia BCA Volume 1& 2.....	7
5. Engineer, Designer and Specification considerations.....	7
Specification .....	7
B. Product Application Requirements .....	8
6. Installation Procedures .....	8
Storage .....	8
Pre -Installation .....	8
Cutting.....	8
Installation Instruction (See Appendix A & B) .....	8
7. Workplace Health and Safety – MSDS .....	9-13
8. Maintenance .....	14, 53, 54
9. Warranty .....	15-16



10.	Quality Management System.....	17
11.	Certification of Registration.....	18
12.	Index of Terms and Wording.....	19
	Onsite Requirements.....	19
13.	Training Introduction.....	20
14.	Checklist – Pre and Post Installation, and Final .....	21-22
	Revision Table.....	23
15.	<b>Appendix A (Timber Frame)</b> .....	

**General Notes**

Gen I: Material’s Feature: Mechanical properties & reaction to fire

Gen II: Material’s Feature: Chemical & Biological features

Gen III: General information on WPO18035 Castellated Profile

Gen IV: Colour & Finishes: Classique and Premium Range

Gen V: Biowood Horizontal Wall Installation Components

Gen VI: Setting out, Butt joints, Control Joints, and H-mould Detail

Gen VII: Acceptable tolerance

**HORIZONTAL Installation Detail Drawings**

Dwg. 01: 3D view of external wall detail of Horizontally laid Biowood Cladding – WPO18035

Dwg. 02: Section view of rebated edge slab detail of Horizontally laid Biowood Cladding – WPO18035

Dwg. 03: Section view of concrete edge slab detail of Horizontally laid Biowood Cladding – WPO18035

Dwg. 04: Plan view of external detail of Horizontally laid Biowood Cladding – WPO18035

Dwg. 05: Plan view of internal corner detail of Horizontally laid Biowood Cladding – WPO18035

Dwg. 06: Section view of window head detail of Horizontally laid Biowood Cladding – WPO18035

Dwg. 07: Section view of windowsill detail of Horizontally laid Biowood Cladding – WPO18035

Dwg. 08: Plan view of window jamb detail of Horizontally laid Biowood Cladding – WPO18035

Dwg. 09: Section view of transverse apron detail of Horizontally laid Biowood Cladding – WPO18035

Dwg. 10: Section view of parallel apron detail of Horizontally laid Biowood Cladding – WPO18035



Dwg. 11: Section view of cladding to soffit detail of Horizontally laid Biowood Cladding – WPO18035

Dwg. 12: Section view of parapet to roof junction detail of Horizontally laid Biowood Cladding – WPO18035

Dwg. 13: Section view of downpipe fixing detail of Horizontally laid Biowood Cladding – WPO18035

**16. Appendix B (STUDCO Frame) .....**

**General Notes**

Gen I: STUDCO Top Hat Span Tables (For Biowood Panels)

Gen II: Setting out, Butt joints, Control Joints and H-mould Detail

Gen III: Acceptable tolerance

**HORIZONTAL Installation Detail Drawings**

Dwg. 01: 3D view of external wall detail of Horizontally laid Biowood Cladding – WPO18035

Dwg. 02: Section view of rebated edge slab detail of Horizontally laid Biowood Cladding – WPO18035

Dwg. 03: Section view of concrete edge slab detail of Horizontally laid Biowood Cladding – WPO18035

Dwg. 04: Plan view of external detail of Horizontally laid Biowood Cladding – WPO18035

Dwg. 05: Plan view of internal corner detail of Horizontally laid Biowood Cladding – WPO18035

Dwg. 06: Section view of window head detail of Horizontally laid Biowood Cladding – WPO18035

Dwg. 07: Section view of windowsill detail of Horizontally laid Biowood Cladding – WPO18035

Dwg. 08: Plan view of window jamb detail of Horizontally laid Biowood Cladding – WPO18035

Dwg. 09: Section view of transverse apron detail of Horizontally laid Biowood Cladding – WPO18035

Dwg. 10: Section view of parallel apron detail of Horizontally laid Biowood Cladding – WPO18035

Dwg. 11: Section view of cladding to soffit detail of Horizontally laid Biowood Cladding – WPO18035

Dwg. 12: Section view of parapet to roof junction detail of Horizontally laid Biowood Cladding – WPO18035

Dwg. 13: Section view of downpipe fixing detail of Horizontally laid Biowood Cladding – WPO18035



# A. General Information

## 1. Product Description, Features and Benefits

Biowood reconstituted wood composite architectural products are a sustainable timber alternative with added benefits such as durability and strength. Best of all, our products are low maintenance and environmentally friendly meaning that you spend less time worrying about them and more time enjoying the benefits of our projects.

Natural Timber Look & Feel: Biowood reconstituted wood composite architectural products are a sustainable timber alternative with added benefits such as durability and strength  
Lightweight & Durable: It was either a lightweight product or a heavy, durable product that you had to choose from. Now you can have the best of both worlds.

### Features and benefits:

- Retaining the natural timber look and feel
- Lightweight and durable
- Flame, termite, and water resistant
- Mould and Mildew resistant
- A proven time-tested product in Australia and New Zealand
- An added value to your investment
- No splinters, crack, or rot

### AU & NZ appraised performance

#### Product range:

Biowood Castellated Façade	WPO	18035	Castellated
Biowood Castellated Façade	WPO	18025A	Castellated
Biowood Castellated Façade	WPO	25028	Castellated
Biowood Castellated Façade	WPO	30060	Castellated

## 2. Product Scope of Use

Our architectural reconstituted wood composite products are designed in Australia and manufactured in Batam, Indonesia.

In order to protect the environment and contribute to the efforts of controlling global warming, we strive to develop new innovative, green products for today's future.

With intensive research and development, we have created a reconstituted wood material and named it Biowood Architectural Reconstituted Composite Wood

Today, we continue to seek, develop, and provide innovative solutions for any customer's needs.

Using Biowood reconstituted wood composite architectural products, it is then possible to continue to achieve and provide you with sustainable, environmentally friendly range of products.



### 3. Product Limitations

Product limitations are limited to regular maintenance:

Your Biowood castellated cladding and ceiling will deliver many years of carefree maintenance. To maintain your pride in the beauty of this product it is recommended that the whole wall is washed down with clean tap water and lightly brushed with a soft hairbrush or broom every three months. This action will remove dust, dirt, debris and atmospheric fall out which will accumulate on the Castellated shoulder where boards have been laid horizontal (see diagram G). Horizontally laid boards are naturally self-cleaning. Wash every 6 months. Bioseal UV Seal Matt or Intergrain Enviropro Endure Deck Stain Satin range are the recommended UV coating if required recoating is required periodically as per the coating manufacturers specifications.

### 4. BCA & NZBC Relevant Performance Clauses

#### Structural performance - Clause B1

The Biowood Weatherboard, Castellated profile cladding and Soffit systems, when used in accordance with the Code Mark Appraisal Certificate, and subjected to normal conditions of environment and use, is expected to tolerate wind forces up to and including Very High, as defined in NZS 3604:2011.

#### Durability - Clause B2

The Biowood Weatherboard, Castellated profile cladding and Soffit systems, when used in accordance with this Appraisal Certificate and subjected to normal conditions of environment and use, is expected to have a serviceable life of at least 50 years according to the design option selected.

#### External Moisture - Clause E2

The installation of the Biowood Weatherboard, Castellated profile cladding and Soffit systems is reliant on the correct application of the Weatherboard, Castellated profile cladding and Soffit systems.

The design of details not included within the Technical Manual are subject to specific design and are outside the scope of this Appraisal Certificate.

#### Hazardous Building Materials - Clause F2

Performance F2.3.1:

The Biowood Weatherboard, Castellated profile cladding and Soffit systems, when installed according to the requirements of this appraisal, meets this requirement, and will not present a health hazard to people using the building.

# NCC and BCA Relevant Performance Clauses

Deem to Satisfy Provision(s): AS3959

Volume 1:

BP1.1(b) (iii) & (viii),

FP1.4 (a) & (b),

GP 5.1

Volume 2:

P2.1.1 (a) & (b) (iii), (iv), (x) & (xii),

P2.2.2,

F2.3.4

## BCS1650 - Approved Timber Framing Sizes for the Biowood Facade

The weathertightness testing carried out by us was to meet wind loads of up to and including 1.8KPa, based on the timber framing being treated H3 in a size of 90mm x 45mm.

### 5. Engineer, Designer and Specification considerations

Designers are responsible for the framing design, and building contractors are responsible for the quality of construction of the framing.

The Biowood Weatherboard, Castellated profile cladding and Soffit systems is for use on new and existing timber framing to provide a wind and moisture resistant barrier when the building is situated in high to very high wind zones. Specification

It is advised that the Architect/Designer or Specifier denote on the building/design plans for the purpose of identifying product use as per the product range stated above.

For accreditation, please refer to the Biowood Weatherboard, Castellated profile cladding and Soffit systems BEAL Appraisal certificate, which can be found on [www.beal.co.nz](http://www.beal.co.nz).

NOTE:

More information, as in Installation Manuals and Brochures can be obtained by emailing us on

[inq@grmaustralia.com.au](mailto:inq@grmaustralia.com.au)

## B. Product Application Requirements

### 6. Installation Procedures

#### Storage

Always lay Biowood Weatherboard, Castellated profile cladding and Soffit on a solid surface and protect it from weather and dirt prior to and during installation. Always protect the corners of Biowood Weatherboard, Castellated profile cladding and Soffit prior to and during installation. Do not stack other materials on top of Biowood Weatherboard, Castellated profile cladding and Soffit.

#### Pre -Installation

Installation of the Biowood Weatherboard, Castellated profile cladding and Soffit sheets must be completed by a GRM approved and trained tradesmen who have experience in the installation of weatherboard cladding and soffits.

It is the responsibility of the approved installer to inspect their workplace prior to beginning the installation of the Biowood Weatherboard, Castellated profile cladding and Soffit to ensure the installed work will meet the owner / contractor(s) requirements.

Special Note: Notify owner / general contractor of any concerns prior to the start of Biowood Weatherboard, Castellated profile cladding and Soffit installation.

The moisture content of any new timber framing must be no higher than 18%.

The application of the Biowood Weatherboard, Castellated profile cladding and Soffit must not be undertaken when the substrate temperature is below 4°C or if it is likely to drop below 4°C during drying/curing time.

#### Cutting

You can easily cut Biowood Weatherboard, Castellated profile cladding and Soffit with a carbide tipped scoring knife, keyhole saw, sabre saw, or power saw equipped with a carbide blade and HEPA vacuum extraction Measure accurately and Mark your cutting locations before cutting.

Make circular cuts and irregular angle cuts using a cement board bit or carbide tipped bit, a keyhole saw, or a sabre saw.

To perform cut outs for electrical outlets, light receptacles, switches, etc., carefully measure and Mark the location of the opening on the face of Biowood Weatherboard, Castellated profile cladding and Soffit.

Outline the opening in pencil and cut it out with a keyhole saw or circle cutter equipped with carbide tipped tooling. The hole must be accurately located and cut to size. Position cutting station so that wind will blow dust away from the user or others in the working area and allow for ample dust dissipation Score and snap using carbide-tipped scoring knife or utility knife (Ability to use this method depends on thickness of Biowood Weatherboard, Castellated profile cladding and Soffit being installed.) Fiber-cement shears (electric or pneumatic) Dust reducing circular saw equipped with appropriate blade and HEPA vacuum extraction. Dust reducing circular saw with appropriate saw blade. Always use correct tools when executing cutting operations.

Even though Biowood Weatherboard, Castellated profile cladding and Soffit is a non-toxic building material, always wear a dusk mask, safety glasses and follow MSDS Guidelines. Never use a power saw indoors. Never use a circular saw blade that is inappropriate for the specific operation being undertaken. Never use a grinder or continuous rim diamond blade for cutting. very dry sweep - use wet suppression methods or HEPA vacuum.



## 7. Workplace Health and Safety – MSDS

All products must be stored inside, in a well-ventilated area, up off concrete floors, kept dry, out of direct sunlight and away from freezing conditions.

MSDS (Material Safety Data Sheet) for the following items can be found below:

Biowood Polymer/Wood Composite Material  
Intergrain Enviropro Endure Deck exterior wood coating.



## MATERIALS SAFETY DATA SHEET

NOT CLASSIFIED AS HAZARDOUS ACCORDING TO CRITERIA OF NOHSC  
CLASSIFIED AS A DANGEROUS GOOD ACCORDING TO ADG CODE

### **i. IDENTIFICATION OF THE MATERIAL AND SUPPLIER**

- |     |                                |   |
|-----|--------------------------------|---|
| 1.  | Identification of the product: | GRM/Biowood Polymer/Wood Composite Material-G3                                      |
| 2.  | Recommend use:                 | Internal & External Applications  |
| 3.  | Supplier:                      | Green Resources Material<br>Australia Pty Ltd Unit 2, 74-80<br>Helen Street, Sefton |
| 1.4 | A.B.N.:                        | 49 145 128 927  |
| 1.5 | Telephone:                     | (+61 2) 9644-6766   |
| 1.6 | Fax:                           | (+61 2) 9644-5633   |
| 1.7 | Emergency Phone Number:        | (+61 2) 9644-6766   |

### **ii. HAZARDS IDENTIFICATION**

- |    |                         |   |
|----|-------------------------|---|
| 1. | Hazards Classification: | Non-hazardous Substance. Non-dangerous good |
| 2. | Risk Phrase(s):         | Non-Allocated                               |
| 3. | Safety Phrase(s):       | Non-Allocated                               |

### **iii. COMPOSITION/INFORMATION OF INGREDIENTS**

Recycle Wood Powder	69%
PVC	23%
CACO3	5%
Other	3%

Ingredients determined not to be hazardous to 100%

**iv. FIRST AID MEASURES**

1. Description of Necessary First Aid Measure:

**Ingestion:** Not applicable under normal condition use

**Eye:** Immediately rinse with water. Remove contact lenses. Hold eyelids apart and flush eyes with water at least 15 minutes. If irritation persists, seek medical attention.

**Skin:** Wash affected areas with soap and water until dust is entirely removed from skin. Immediately remove contaminated clothing. If rash, dermatitis, or irritation persist, seek medical attention. Launder contaminated clothing before reuse of properly.

**Inhalation:** Remove to fresh air immediately. If breathing is difficult, trained personnel should administer oxygen. If breathing has ceased apply artificial resuscitation using oxygen and a suitable mechanical device such as a bag and a mask. Get immediate medical attention.

**v. FIRE FIGHTING MEASURES**

- |  |  |
|--|--|
| 1. Suitable Extinguishing Media:                                 | Water, carbon dioxide or sand  |
| 2. Hazards from Combustion Products:                             | Thermal-oxidative degradation, or burning, of wood can produce irritating and potentially toxic fumes and gases including carbon monoxide, baldheads, and organic acids. |
| 3. Precaution for Fire Fighter and Special Protective Equipment: | Not Applicable   |

**vi. ACCIDENTAL RELEASE MEASURES**

- |  |  |
|--|--|
| 1. Emergency Procedures:   | Non required   |
| 2. Methods and material for containment and clean up procedures: | Wood dust may be vacuumed or shoveled for recovery or disposal. We down accumulated dusts prior to vacuuming or shoveling to prevent explosion hazards. Avoid dusty conditions and provide good ventilation. Wood dust clean-up and disposal activities should be accomplished in a manner to minimize creation of airborne dust. Do not inhale dusts during clean-up. |

**vii. HANDLING AND STORAGE**

- |                                   |  |
|-----------------------------------|--|
| 1. Precautions for Safe Handling: | Avoid repeated or prolonged breathing of wood dust. Avoid eye contact or repeated or prolonged contact with skin. Change protective clothing and gloves when sign of contamination appears.  |
| 2. Condition for Safe Storage:    | Material should not be subjected to temperatures. Exceeding the auto ignition temperature. Water Spray may be used to wet down wood dust Generated by sawing or machining to reduce the Likelihood of ignition or dispersion of dust into the air. |



**viii. EXPOSURE CONTROL/PERSONAL PROTECTION**

1. National Exposure Standards:
2. Biological Limit Values: No biological limit allocated.
3. Engineering Control: Due to the explosive potential of wood when suspended in air, precautions should be taken during sanding, sawing, or machining of wood products to prevent spark or other ignition sources in ventilation equipment. Use of totally enclosed motors is recommended.
4. Personal Protective Equipment

**Eye:** Recommend goggles or safety glasses as conditions indicate when sawing, sanding, or machining wood products

**Skin:** Protective equipment such as gloves and outer garments may be needed to reduce skin contact. After working with the wood and before eating, drinking, toileting and use of tobacco products, wash exposed areas thoroughly.

**ix. PHYSICAL AND CHEMICAL PROPERTIES**

Physical Description/Properties:	
Physical Form, color, and odor:	Solid
Vapor Pressure:	Not Applicable
Boiling Point:	Not Applicable
Vicat Softening Temperature:	83°C
Solubility in Water:	Insoluble
Specific Gravity @ 25°C	<1.0

**x. STABILITY AND REACTIVITY**

1. Chemical Stability: Stable
2. Condition to Avoid: None known
3. Incompatible Material: Oxidizing agents and drying.
4. Hazardous Decomposition Products: Oils None know
5. Hazardous Reactions: Hazardous polymerization will not occur.

**xi. TOXICOLOGICAL INFORMATION**

**WOOD DUST:**

Wood dust generated from sawing, sanding or machining this product may cause nasal dryness, irritation, coughing and sinusitis. The International Agency for Research on Cancer (IARC) and the National Toxicology Program (NTP) classify wood dust as a (known) human carcinogen (Group I). This classification is based primarily on increased risk in the occurrence of adenocarcinomas of the nasal cavities and paranasal sinuses associated with exposure to wood dust. The evaluation did not find sufficient evidence to associate cancers of the oropharynx, hypopharynx, lung, lymphatic and hematopoietic systems, stomach, colon or rectum with exposure to wood dust.



**xii. ECOLOGICAL INFORMATION**

This product is not expected to have ecological effects on the environment.

**xiii. DISPOSAL CONSIDERATIONS**

1. Disposal Methods: Waste should be placed in containers, plastic bags or other methods which prevent dust emission, and disposal of in accordance with the local waste disposal authority requirements.
2. Special Precaution for Landfill Incineration: None know

**xiv. TRANSPORT INFORMATION**

- |  |                |
|--|----------------|
| 1. UN Number:                              | Non allocated  |
| 2. UN Proper Shipping Number:              | Non allocated  |
| 3. Dangerous goods (Class and Subs Risks): | Non allocated  |
| 4. Special Precautions for User:           | Not applicable |
| 5. Hazchem Code:                           | Not applicable |

**xv. REGULATORY INFORMATION**

- |  |   |
|--|---|
| 1. SUSDP Poisons Schedule Number:                              | Non allocated   |
| 2. Prohibition/Licensing Requirements:                         | There are no applicable prohibition or notification. /Licensing requirements, including for carcinogens under Commonwealth, State or Territory Legislation. |
| 3. Industrial Chemical (Notification and Assessment) Act 1989: | All ingredients are listed on or exempt from the Australian Inventory of Chemical Substance (AICS)  |

Disclaimer: This information is based on our current knowledge and is intended to describe the product for the purpose of health, safety and environmental requirements only. Since Green Resources Material Australia Pty Ltd cannot anticipate or control the conditions under which the product may be used, each user must, prior to usage, review this MSDS in the context of how the user handle and use the product.

## **8. Maintenance**

Once the Biowood Weatherboard, Castellated profile cladding and soffit has been installed as per this technical manual and as required by the NZBC & BCA, further maintenance is required as stated.

The whole wall should be washed down with clean tap water and lightly brushed with a soft hairbrush or broom every three months.

This action will remove dust, dirt, debris, and atmospheric fall out which will accumulate on the Castellated shoulder where boards have been laid Horizontal (see diagram G). Horizontally laid boards are naturally self-cleaning. Wash every 6 months.

## **9. Warranty**

Biowood Material Warranty can be found below.

## 15 Years Biowood Material Warranty

GRM (Aust.) Pty Ltd (“Biowood”) warrants its entire composite product, in its original manufactured state, to be free from manufacturer’s defects subject to the term’s conditions and limitations.

GRM (Aust.) Pty Ltd (“Biowood”) warranty is for a period of 15 years, from the date of purchase of the Biowood products, warrants its products to be resistant to cracking, splitting, swelling, or rotting, flaking, or peeling, water and moisture and to termites and other vermin. Excluding any mechanical problem such as indentation, scratches and/or surface damage caused by lack of proper protection and/or maintenance, moisture problems, or abuse. Color & gloss reduction is not considered surface wear. It is to be expected a 5% color fading yearly due to normal wear and tear.

Biowood is a natural product, containing natural variations in color, tone, and grain. GRM (Aust.) Pty Ltd (“Biowood”) cannot guarantee against natural variations in each plank, nor differences between sample and color of the floor. The installer is responsible for inspecting each plank for color, finish, size and other quality issues prior to installation. Should there be any defects noted prior to installation, GRM (Aust.) Pty Ltd (“Biowood”) will replace the defective planks. GRM (Aust.) Pty Ltd (“Biowood”) does not warrant installation, nor is it covered in claims.

GRM (Aust.) Pty Ltd (“Biowood”) warranty does not cover indentations, scratches, or damages cause by negligence, exposure to extreme heat (\*outside of normal environmental conditions and caused by human misuse of the product), dryness or water saturation, accidents, abuse, misuse, indentations from heels or pets, stains because of chemical or industrial products, insufficient protection, or improper alterations of the original manufactured product.

GRM (Aust.) Pty Ltd (“Biowood”) may provide recommendations on installation. GRM (Aust.) Pty Ltd (“Biowood”) does NOT warranty any of these recommendations or products, including but not limited to installation tools such as staple guns, installation instructions, finishes, and cleaners. Please consult the manufacturers of these products and or the installer for warranty information.

GRM (Aust.) Pty Ltd (“Biowood”) is not a shipping company and cannot warrant damage that may have occurred while in transit. It is the customer’s responsibility to inspect all material upon arrival. If any damage is found it must be documented on the original bill of lading and is the customer’s sole responsibility to seek compensation from the shipping company. Each customer has the right to arrange their own shipping.

The warranty is given under normal environmental conditions, for which the products are designed, without the harm of external elements and chemical corrosion, through misuse and or improper storage, handling, application, finishing and or poor maintenance; alterations to the structure supporting the Biowood products, after the original installation of the products; act of terrorism or war; natural disaster events, such as hurricanes, tornados, hail, earthquakes, floods, fire or other similar causes beyond the control of Biowood.

There are no express or implied warranties except as stated herein and under the current Australian federal and state legislation, and there are no implied warranties of the merchantability and fitness for a particular purpose and no representative has the authority to make any representations other than those stated herein.

The products must be installed, coated and maintained in accordance with the Biowood current and relevant specifications, instructions in strict compliance with the current provision of the BCA, regulations and standards, current at the time of installation.

The coating/varnish, fasteners and fixings must be of appropriate materials and used in accordance with Biowood specifications. That care of the Biowood product is maintained as per maintenance instructions provided by Biowood.

Biowood shall under no circumstances be liable for incidental consequential damages, including but not limited to injury to any person or damages to the building or the contents of the building, including any such damages relating to the presence of damp, mould, or mildew.

This warranty shall not be applicable to damage, loss or consequential loss caused in whole or in part by and does not provide protection against any failure, defect or damage caused by situations and events beyond normal usage or exposure conditions, including but not limited.

- a) natural disaster events, including but not limited to lightning, wind gusts in excess of the design wind speed for the building, hail or
- b) similar natural disaster events.
- c) vandalism, acts of war, or civil disturbances.
- d) environmental fallout or overexposure to commercial and or industrial solvents, acids, caustic fluids, oils, waxes, greases,
- e) absorbent clays, bleaches, plasticizers, or other harmful chemicals.

The products are not warranted against discoloration or other damage caused by air pollution, mildew, exposure to harmful chemicals or normal weathering from the elements, normal weathering is defined as exposure to sunlight and extremes of weather and atmosphere which will cause any colored surface to gradually fade, chalk, or accumulate dirt or stains. The severity of any condition depends on the geographical location of the product, the cleanliness of the air in the area, and many other influences over which Biowood has no control; Biowood shall have sole discretion to determine, based on reasonable criteria, whether the product is suffering from normal weathering. If the product weathers to a degree determined by Biowood to be beyond normal, Biowood may provide replacement material, at its option, for the defective product. Biowood also reserves the right to refund the amount paid by the original purchaser for the product material (but not including the cost of its initial installation & logistic cost)

#### **How to get Warranty Service?**

The claimant shall provide GRM with written notice & proof of purchase of any material product defect of any claim under this warranty within (30) days, after the defect would have become reasonably apparent. If the defect was reasonably apparent prior to installation, then the claim must be made prior to installation and if any such defective products are installed then this warranty is negated. Such notice shall be given by certified mail to Green Resources Material Australia Pty Ltd [email.ncr@grmaustralia.com.au](mailto:email.ncr@grmaustralia.com.au)

Biowood may request additional information. After reviewing all information, Biowood will decide regarding the validity of such claim. If Biowood determines that Purchaser's claim is valid, Biowood will, at its option, either replace the defective Biowood Products or refund the portion of the purchase price paid by Purchaser for such defective Biowood Products (not including the cost of its initial installation & logistic cost).

If Biowood investigation of any claim under this warranty reveals that Biowood is not responsible under the terms of this warranty for the purchaser's claim, the purchaser shall promptly reimburse the investigation costs incurred by Biowood.

#### **Exclusion of damages:**

Consequential loss shall mean the indirect or special loss and or damage arising from a breach of the purchase contract, tort(including negligence), under statute and or any other basis in law or equity including, but without limitation, the following:- (i) loss of profits; (ii) loss of revenue; (iii) loss of production; (iv) loss or denial of opportunity;(v) loss of access to Markets;(vi) loss of good will;(vii) loss of business reputation or future reputation or publicity; (viii) damage to credit rating; and or loss of use;(ix) or any similar loss whether or not in the reasonable contemplation of the parties at the time of the execution of the purchase.

#### **Effective law:**

This warranty is subject to the laws of the state of Victoria. This warranty gives you specific legal rights, and you may also have other rights, which vary from state to state. Nothing in this warranty limits or restricts, or is intended to derogate from, any right or remedy which the purchaser or ultimate user of the product may have pursuant to Australian state and/or Australian Federal Consumer Protection Legislation, New Zealand Sale of Goods Act, Consumer Guarantees Act, Fair Trading Act or any other relevant and applicable New Zealand legislation





## **Biowood Seal of Approval**

### **a. Quality Management System**

GRM Australia products are manufactured in Malaysia by PT. Latrade Batam Indonesia. They are certified to both the Quality Management System, ISO 9001: 2015 and the Environmental Management System ISO 14001:2015 and Green Resources Material Australia Pty Ltd ensures that the Building Product Quality Plan (BPQP) is managed to ensure that the product will meet the Manufacture Quality Plan (MQP) as required by the CodeMark Scheme Rules and ISO10005.

Their current Latrade Batam Indonesia certificates are found below:



# Certificate of Conformity

Certification Body:

Certificate number: CM70122 Rev3



**BUREAU VERITAS**

Bureau Veritas Australia Pty Ltd  
Level 11/500, Collins Street,  
Melbourne VIC, 3000  
Ph: 1800 855 190  
www.bureauveritas.com.au

Certificate Holder:



Green Resources Material  
Australia Pty Ltd  
Unit 2, 74-80 Helen Street  
Sefton NSW, 2162  
Ph: 02 9644 6766  
www.grmaustralia.com.au

THIS TO CERTIFY THAT

## Green Resources Material – Biowood Cladding

Type and/or use of product:

Composite wood cladding for use in construction of external wall and soffit applications.

Description of product:

The Green Resources Materials - Biowood Shiplap Weatherboards, Castellated profile Claddings and are a range of exterior cladding elements, manufactured from a proprietary plastic wood composite material. They are attached to the framing of a building. The Green Resources Materials – Biowood product range includes

- Castellated Façade boards of 180mm x 35mm,
  - Outdoor Wall Panel Shiplap boards of 150mm x 18mm
- Both available in 5850mm lengths.

COMPLIES WITH THE FOLLOWING BCA PROVISIONS AND STATE OR TERRITORY VARIATION(S)

**BCA 2022**

Performance Requirement(s)	Volume One	Structural Reliability	Volume Two	Structural reliability and resistance
	B1P1(1), limited to (2)(c) F3P1	Weatherproofing	H1P1(1), limited to (2)(c) H2P2	Weatherproofing
Deemed-to-Satisfy Provision(s):	G5D3 – up to BAL 29 G5D4 – up to BAL 12.5, see conditions and limitations	Protection – residential buildings & certain class 9 buildings	H7D4 – up to BAL 29	Construction in bushfire prone areas
State or territory variation(s):	NSW G5D3 NSW G5D4 VIC G5D4	Protection – residential buildings & certain class 9 buildings	NSW H7D4	Construction in bushfire prone areas

Sam Guindi – Product Certification Manager  
Bureau Veritas Australia Pty Ltd

Harley Parkes - Unrestricted Building Certifier  
Jensen Hughes Pty Ltd

Date of issue: 2 August 2022

Revalidated: 31 July 2025

Date of expiry: 2 August 2028



Certificate number: CM70122 Rev3

This certificate is only valid when reproduced in its entirety.

Page 1 of 8



## CERTIFICATE OF REGISTRATION

THIS IS TO CERTIFY THAT THE MANAGEMENT SYSTEM OF

### PT. Latrade Batam Indonesia

Latrade Industrial Park Block E-3, Jalan Sei Binti, Tanjung Uncang Batam 29422, Indonesia

HAVE BEEN ASSESSED AND CERTIFIED BY ADVANCED SYSTEM ASSURANCE PTE LTD (ASA) AS COMPLYING WITH THE REQUIREMENTS OF THE STANDARD

### ISO 9001:2015

CERTIFICATION SCOPE

Design and Manufacturing of Environmental Sustainable Profile and Pellet Products

This certificate remains valid contingent upon the organization's management system maintaining satisfactory operations and the successful completion of annual surveillance audits.

AUTHORISED BY

CHIDAMBARAM PILLAI, CERTIFICATION DIRECTOR

ADVANCED SYSTEM ASSURANCE PTE. LTD.  
#09-23, UB One, 81 Ubi Avenue 4  
Singapore 408830  
T: +65-6444 1218  
Reg No: 201609440C



CERTIFICATE NUMBER ASA-00607  
ORIGINAL REGISTRATION DATE 19/07/2018  
RE-ISSUE DATE 02/08/2024  
1st SURVEILLANCE DUE DATE N/A  
2nd SURVEILLANCE DUE DATE 01/08/2025  
CERTIFICATE EXPIRY DATE 13/08/2026



This Certificate remains the property of Advanced System Assurance Pte Ltd and must be returned upon reasonable request.



## 10. Onsite Requirements

### a. Installer / Applicator (Approved Training and Register)

All training is supplied by GRM Australia. Please find below the training course as presented to all installers. A list of all personnel trained is kept by GRM Australia and follows the following format:

Company	Person Trained	Preparation	Installation (Outdoor panel)	Installation (Castellated facade)			Date trained	Refresher Date trained (if required)
	Person trained 1	Y	N	Y			02/18	02/20
	Person trained 2	Y	Y	N			02/18	02/20
	Person trained 3	Y	Y	Y			02/18	02/20

# TRAINING INTRODUCTION

Thank you for making the effort in wanting to become accredited in the understanding of Biowood products and methods of specifying, detailing, and installing them.

During this course, the following topics will be discussed.

1. What is WPC (Wood Plastic Composite)? A new way of thinking.
2. Manufacturing of Biowood products.
3. Properties and behavior of Biowood products.
4. How to specify Biowood products.
5. How to assess the suitability of Biowood products to the application of various sites?
6. How to detail fixing methods of Biowood products?
7. Planning a project for Biowood application.
8. Resources available and needed for the proper installation of Biowood products.
9. Theory of the installation methods of Biowood products.
10. Practical installation methods of Biowood products.
11. Testing the theory and practical knowledge and skills of Biowood products.
12. Awarding of Certificate of Competency to qualified participants of course.

8. Checklist – Pre, Post Installation and Final

**ON SITE CHECKLIST for GRM AUSTRALIA APPLICATORS Building/Framing  
Installer Checklist (Doc BPQP App B)**

DATE: \_\_\_\_\_

CONSENT #: \_\_\_\_\_

OWNER/APPLICANT: \_\_\_\_\_

ARCHITECT/DESIGNER/ENGINEER: \_\_\_\_\_

CONSENT ADDRESS: \_\_\_\_\_

NAME OF BUILDER / FRAMINGSUPPLIER: \_\_\_\_\_

- 
- |    |   |          |
|----|---|----------|
| 1. | Framing installed as per designer's drawings  | YES / NO |
| 2. | All pipe penetrations properly supported  | YES / NO |
| 3. | The moisture content of any new timber framing must be no higher than 18%.<br>Require moisture meter to test moisture content | YES / NO |
| 4. | Wall wrap installed compliant with the Building Code with all seams<br>and penetrations sealed                                | YES / NO |

SIGNATUREOFBUILDER/FRAMINGSUPPLIER/INSTALLER: \_\_\_\_\_

# Batten/Panel Installer Checklist (Doc BPQP App B)

NAME OF BATTEN/PANELINSTALLER: \_\_\_\_\_

---

- |  |          |
|--|----------|
| 1. Battens installed as per GRM AUSTRALIA Technical Manual                 | YES / NO |
| 2. Panels installed as per GRM AUSTRALIA Technical Manual                  | YES / NO |
| 3. All penetrations sealed as per GRM AUSTRALIA Technical Manual           | YES / NO |
| 4. Control Joints (if any) installed as per GRM AUSTRALIA Technical Manual | YES / NO |
| 5. Window and Door flashings as per GRM AUSTRALIA Technical                | YES / NO |
| 6. Panel joints, edges or defects properly flashed with adhesive           | YES / NO |

SIGNATURE OF BUILDER/BATTENINSTALLER: \_\_\_\_\_

COMMENTS:

---

---

---

---

---

---

---

**Attach certificates and photographs as evidence of compliance.**

## 9. Revision Table

Version number	Purpose / Change	Author	Date
Draft	Draft Improvements and Final	John Villani	Nov/01/2018
1.0	Draft Improvements and Final	Melvin Fontanilla	June/15/2021
2.1	Draft Improvements and Final	Melvin Fontanilla	July/28/22
2.2	Draft Improvements and Final Updated ISO 9001 Certificate & Include Codemark Certificate on Page 18 and Timber screws 8 Gx 32 or 30 mm 316/304 stainless screws & Soudalflex 42 FX & SMX 50 Adhesives page 32	Melvin Fontanilla	Feb/01/2026

# Appendix A



# MATERIAL'S FEATURE

## Mechanical properties

Density (kg/m <sup>3</sup> ), average	ASTM D2395: 2007a	1178 kg/m <sup>3</sup>
Shore D Hardness, median	ASTM D2240 : 2000	68
Water Absorption a.) after 2h b.) after 24h	ASTM D1037 :2006a, Section 23, Method A	+0.08% +0.47%
Nail Pull Resistance (N), average	ASTM D1037 : 2006a, Section 14	276 N
Maximum Tensile Strength (MPa), average Modulus of Elasticity (MPa), average Elongation at Break (%), average	ASTM D638 ; 2003	6.1 Mpa 1110 Mpa 1.2
Flexural Strength (MPa), average Modulus of Elasticity (MPa), average	ASTM D6109 : 2005	23.6 2251
Maximum Compressive Strength (MPa), average	ASTM D695 : 2002a	193
Coefficient of Thermal Expansion a.) $\alpha_1$ (40 to 70 °C), $\mu\text{m}/\text{m}^\circ\text{C}$ b.) $\alpha_1$ (95 to 105 °C), $\mu\text{m}/\text{m}^\circ\text{C}$	ASTM E831 : 2000	53.7 81.4
Vicat Softening Temperature °C	ASTM D1525:2009	84
Linear Coefficient of Thermal Expansion $\mu\text{m}/\text{m}^\circ\text{C}$	ASTM D6341:2016	27.7
Static Water Penetration NCC 2019 Amendment 1 FV1.1c)i)B) NCC 2019 Amendment 1V2.2.1 c)i)C) Vipac Engineers & Scientists Limited	Test Pressure FP1.4 & 4284 +455pa	Complies
Cyclic Water Penetration NCC 2019 Amendment 1 FV1.1c)i)B) NCC 2019 Amendment 1V2.2.1 c)i)C) Vipac Engineers & Scientists Limited	Test Pressure FP1.4 & 4284 208a-455Pa 303Pa – 606Pa 455Pa-910Pa	Complies



# MATERIAL'S FEATURE

## Reaction to fire

Biowood Classique Group Rating	AS/NZS 3837:1998 In accordance with Specification C1.10 Section 4 of the BCA	Group 3
Average specific extinction area	AS/NZS 3837:1998 In accordance with Specification C1.10 Section 4 of the BCA	231 m <sup>3</sup> /kg
Biowood Premium Range BAL-29 Rated	25-kWm/2 irradiance in accordance with AS/NZS 3837:1998	Up to BAL-29 condition, as specified in AS 3959:2009 Construction of Buildings in bushfire- prone area Appendix F.
Average Critical Radiant Flux (CRF) Average Integrated Smoke Value	AS ISO 9239.1-2003	10.2 kW/m <sup>2</sup> 71% x min
Ignitability, flame propagation, heart release and smoke release	AS/NZS 1530.3 : 1999	Ignitability (0-20) = 13 Spread of Flame (0-10) = 0 Heat Evolved (0-10) = 1 Smoke Developed (0-10) = 7
Average Critical Radiant Flux (CRF)	AS ISO 9239.1-2003	10.2 kW/m <sup>2</sup>



These values shown are indicative and not binding. Nata Certified test reports available upon request.

The product is protected by a warranty in line with legal requirements: for more information see [www.grmaustralia.com.au](http://www.grmaustralia.com.au)

# MATERIAL'S FEATURE

## Chemical & biological features

Anti-Fungus Test	ASTM Designation: G21-15	0 ( No growth)
Asbestos Test	TUV (NIOSH) 9002-Asbestos(bulk) by Polarized Light Microscopy	No Asbestos fibers
Formaldehyde emission	EN 717-2:1994 - Determination of Formaldehyde Release- Part 2	0.03 mg/m <sup>2</sup> /hr (Formaldehyde)
Formaldehyde emission	ASTM D5116	<0.01 mg/m <sup>2</sup> /hr (VOC)
ATWA Accelerated Weather Report	18-002698 ISO 105-A02 Where 5 = No Change, 1 = Severe Change @ 1000 hours	4-5

ACCELERATED AGING RESISTANCE TEST COLOUR STABILITY: Colour stability has been tested in compliance with accelerated weathering tests by AWTA Nata certified Test Laboratory (ISO 105/A02); the result of the test is expressed by assigning a numerical value to colour variation according to the international greyscale, which is a useful method to measure colors differences.

PURPOSE OF THE TEST: Resistance to accelerated aging on Biowood profiles according to AWTA Nata certified (ISO 105/A02)

TEST METHOD: The equipment used is Standard for Accelerated Exposure of Automotive Exterior Materials Using a Controlled Irradiance Xenon-Arc Apparatus



These values shown are indicative and not binding. Nata Certified test reports available upon request.

The product is protected by a warranty in line with legal requirements: for more information see [www.grmaustralia.com.au](http://www.grmaustralia.com.au)

# GENERAL INFORMATION

Key points to follow before and during the installation process:

- Store the materials or when delivering on a flat surface providing stable support on the whole surface and supported at 600mm centers, in a dry, clean area, protected from frost and direct sunlight. Do not overhang or cantilever from trucks delivery.
- Before starting the installation, carefully check the materials and notify immediately of any manufacturing issues. Complaints will not be accepted after installation.
- Before starting the installation, check project's drawings (or shop drawings if provided) and the correspondence of the received material against the packing list.
- Acclimate the material in stock to the temperature of the jobsite for at least 48 hours prior to installation.
- The temperature of the boards should be about 18°C when cutting lengths. It is most important that all boards are cut to length and installed at the same temperature when cut.
- When installing the Biowood boards do not fix directly to sarking. Where **sarking is required, double battening is recommended** to ensure adequate adhesion between Biowood and the substrate. **Use 70x35mm or 90x45mm H3 Timber Pine Battens or STUDCO Top Hat screwed** to studs as per specification for the Biowood color chosen.
- When using Spotted Gum, Natural Oak, Lexicon White, Western Red Cedar and Driftwood a maximum of 450 mm span center batten spacing is recommended.
- **When using Black Japan, Weatherwood, Charred Wood, Smoked Oak and Deep Walnut a maximum of 300mm span center batten spacing is recommended.**
- Do not cover the product with sheets made with non-breathable material (nylon, polyethylene, and similar materials). For this purpose, it is advisable to use breathable material such as painter felt sheets.
- The accumulation of electrostatic charges is a natural phenomenon commonly found in plastic materials, and under exceptional environmental conditions this may also occur in Biowood products.
- Profile shall be handled with care to prevent damage. It is recommended to lift the profile on the whole length during displacement and not make them slide on top of each other. Always use clean fabric gloves when handling profiles.
- Prevent the formation of dirt on and between profiles. Make sure that mechanical processes carried out on other materials near Biowood products do not determine the accumulation of chips or dust of any kind. During the installation/assembly phase do not apply labels or stickers, if already applied, please remove immediately after installation. Major stains such as paint, concrete, or tar residues must also be removed immediately.
- For warranty and care recommended uv seal refer to page 15-16. The Biowood warranty will be rendered null and void in the event of incorrect or improper handling, cleaning, and maintenance.
- WPO18035 Profile Drawing Detail

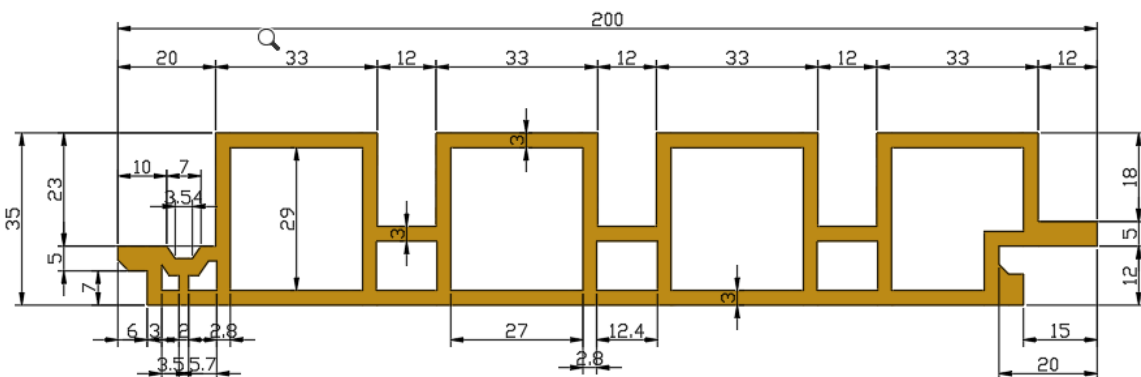

28

WPO18035HRZTL010226.VER2.2

## COLOURS & FINISHES: CASTELLATED

### Classique Range: Profile WPO18035

Brushed UV Sealed (Indoor & Outdoor Application)



Spotted Gum- Bioseal UV Seal Brown

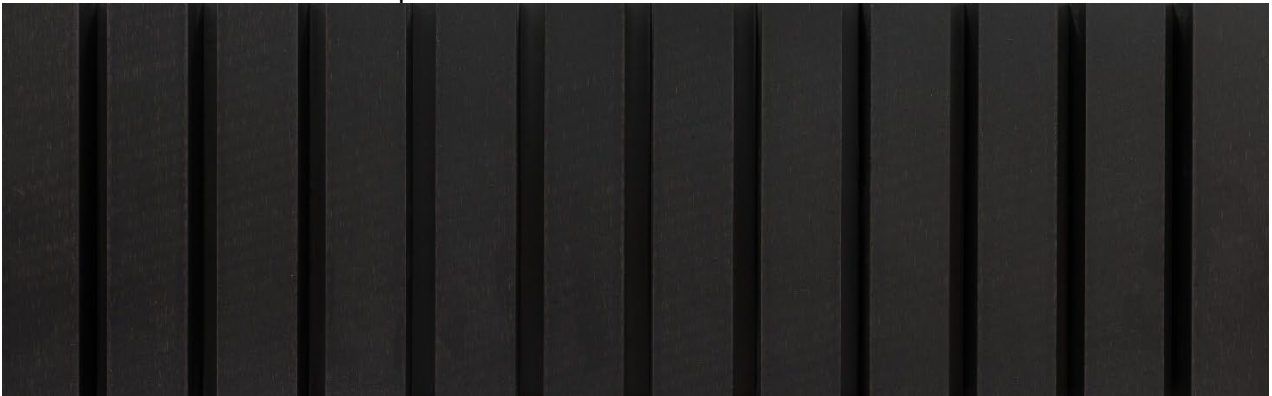

Black Japan – Bioseal UV Seal Black



Western Red Cedar- Bioseal UV Seal Clear

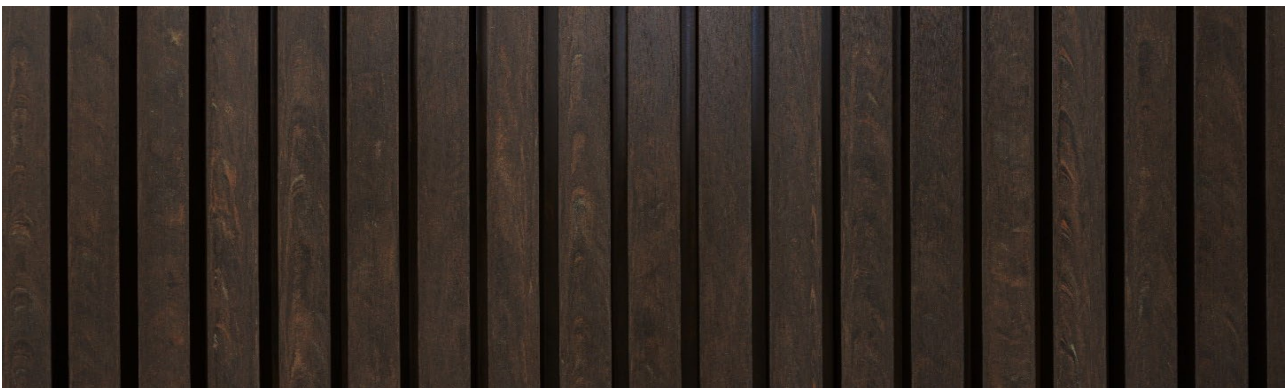

Aparto Walnut – Bioseal UV Seal Black Brown

## COLOURS & FINISHES: CASTELLATED

### Premium Range: Profile WPO18035

Brushed UV Sealed (Indoor & Outdoor Application)



Lexicon White – Bioseal UV Seal Lexicon White

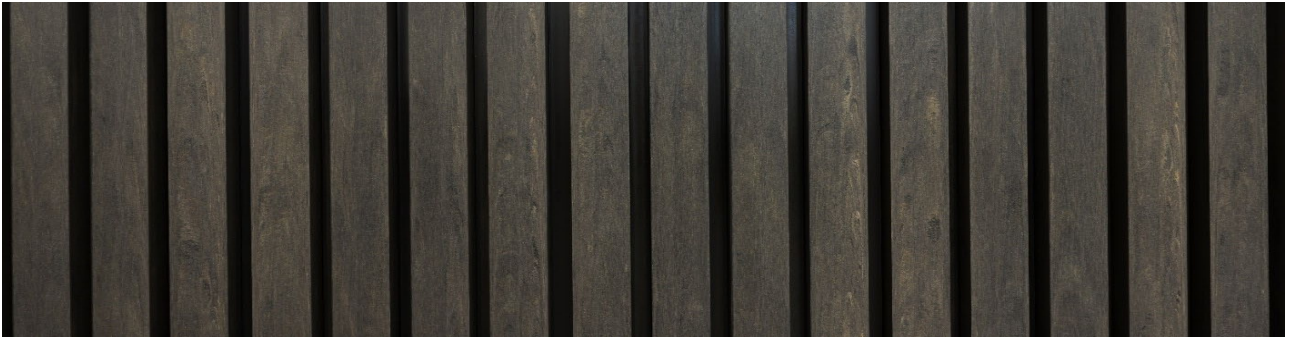

Weatherwood – Bioseal UV Seal Clear



Natural Oak- Bioseal UV Seal Clear



Driftwood Light Grey - Bioseal UV Seal Clear

Colors and textures shown are purely indicative. Check a real sample every time for approval.

Biowood is classified as natural product. Considering the presence of natural wood fibers, colors and grain variation is to be expected from batch to batch.

## COLOURS & FINISHES: CASTELLATED

Two Tone (Black or White Rebate) Premium Range: Profile WPO18035  
Brushed UV Sealed (Indoor & Outdoor Application)



Spotted Gum with Black Rebate – Bioseal UV Brown



Natural Oak with White Rebate – Bioseal UV Seal Clear



Weatherwood with White Rebate – Bioseal UV Seal Clear

Colors and textures shown are purely indicative. Please check our real samples for approval. Biowood is classified as natural product. Considering the presence of natural wood fibers, colors and grain variation is to be expected from batch to batch.

## BIOWOOD COMPONENTS

<p>Biowood board WPO18035</p>	<p>180mm x 35mm x 5850mm 180mm actual cover Weight: 10.2 kg per m<sup>2</sup></p>	
<p>Ali Angle</p>	<p>50mm x 50mm x 3mm</p>	
<p>H Mould 20 mm Face</p>	<p>60mm x 35mm x 5850mm</p>	
<p>Soudalflex 42FX for timber frames (Silver Sausage) Multibond SMX 50 for metal and timber frames (Black Sausage)</p>	<p>600g sausage 2 pcs/sqm</p>	
<p>30mm x 8g Galvanized steel class 3 countersunk screw for metal frames</p>	<p>32 pcs/sqm based on 450 mm maximum span centers</p>	
<p>32 or 30 mm x 8g Stainless steel 316/304 countersunk screw for timberframes</p>	<p>32 pcs/sqm based on 450 mm maximum span centers</p>	
<p>Aluminum J Track (odd leg channel) Black, Brown, Monument, Stone Beige, Lexicon Quarter, Monument, Mid Bronze and Grey</p>	<p>38.70mm x 40mm x 4.20m</p>	

## SETTING OUT

Inspect plan and site measurements prior to installation. Substrate straightness must be checked for Biowood boards will follow any unevenness against battens. Boards should be set out depending on the width to minimize waste and butt joints. In circumstances where sarking is present, double battening of 70x35mm H3 Timber pine battens is recommended to ensure adequate adhesion between Biowood and the substrate.

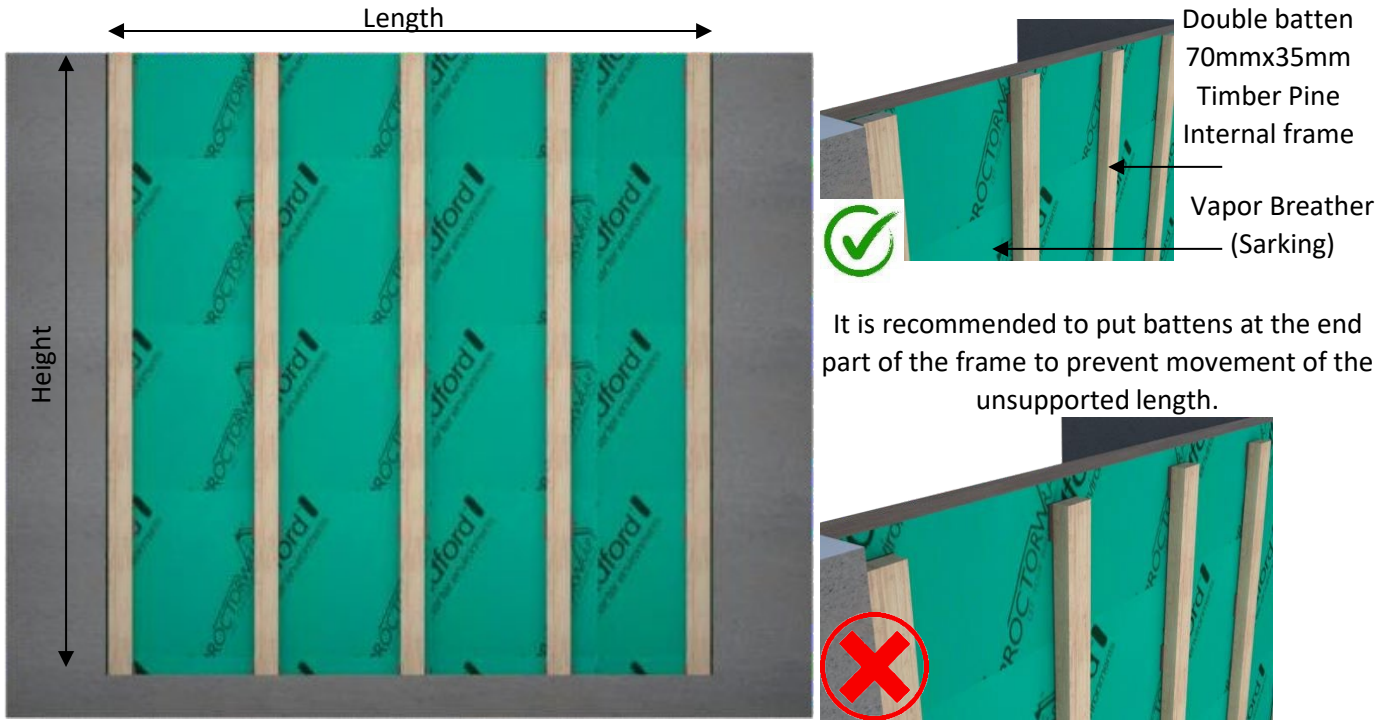

## Recommended Span Centers & Application on Sarking

Maximum span center of 450mm battens spacing: Spotted Gum, Natural Oak, Western Red Cedar and Driftwood.

**Maximum span center of 300mm batten spacing: Black Japan, Weatherwood, Charred Wood and Deep Walnut.**

**Glue and two screws procedure are not applicable to be directly applied to sarking; double battening is recommended.**

## BUTT JOINTS AND CONTROL JOINTS

Biowood will expand and contract in length due to weather conditions. Although this movement will be minor, it is important to make allowances in your design to accommodate this movement. At each end of every board an expansion gap must be allowed of widths varying from a minimum of 3mm to a maximum of 6mm, see below Tables 1 and 2.

### Single boards run expansion gaps.

Board length	Gap at each end
1000mm to 3000mm	3mm
3001mm to 4500mm	4mm
4501mm to 5850mm	5mm

## Multiple board run expansion gap

Maximum board length	Gap at butt joint
5850mm	6mm

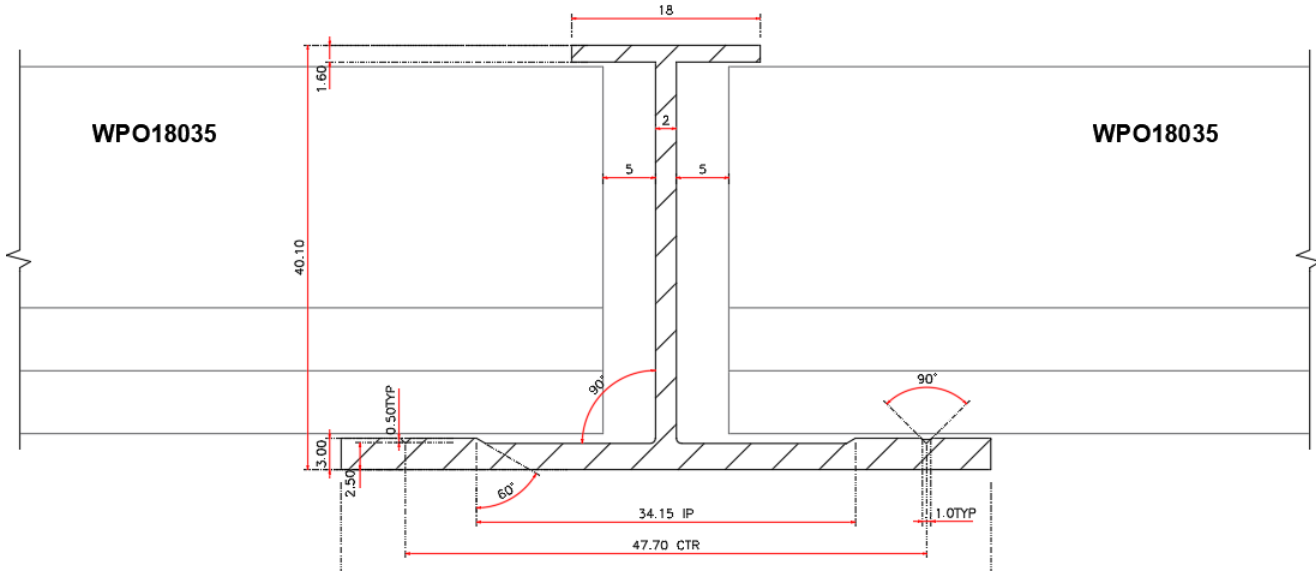

**H Mould 20 mm face lips** are used to conceal the joints between two boards, allowing 5mm clearance in lengthways only

### ACCEPTABLE TOLERANCE

	Cupping: 3mm across 180mm width
	Edge bowing: 10mm over the entire length of 5850mm
	Bowling: 15mm along the entire length of 5850mm

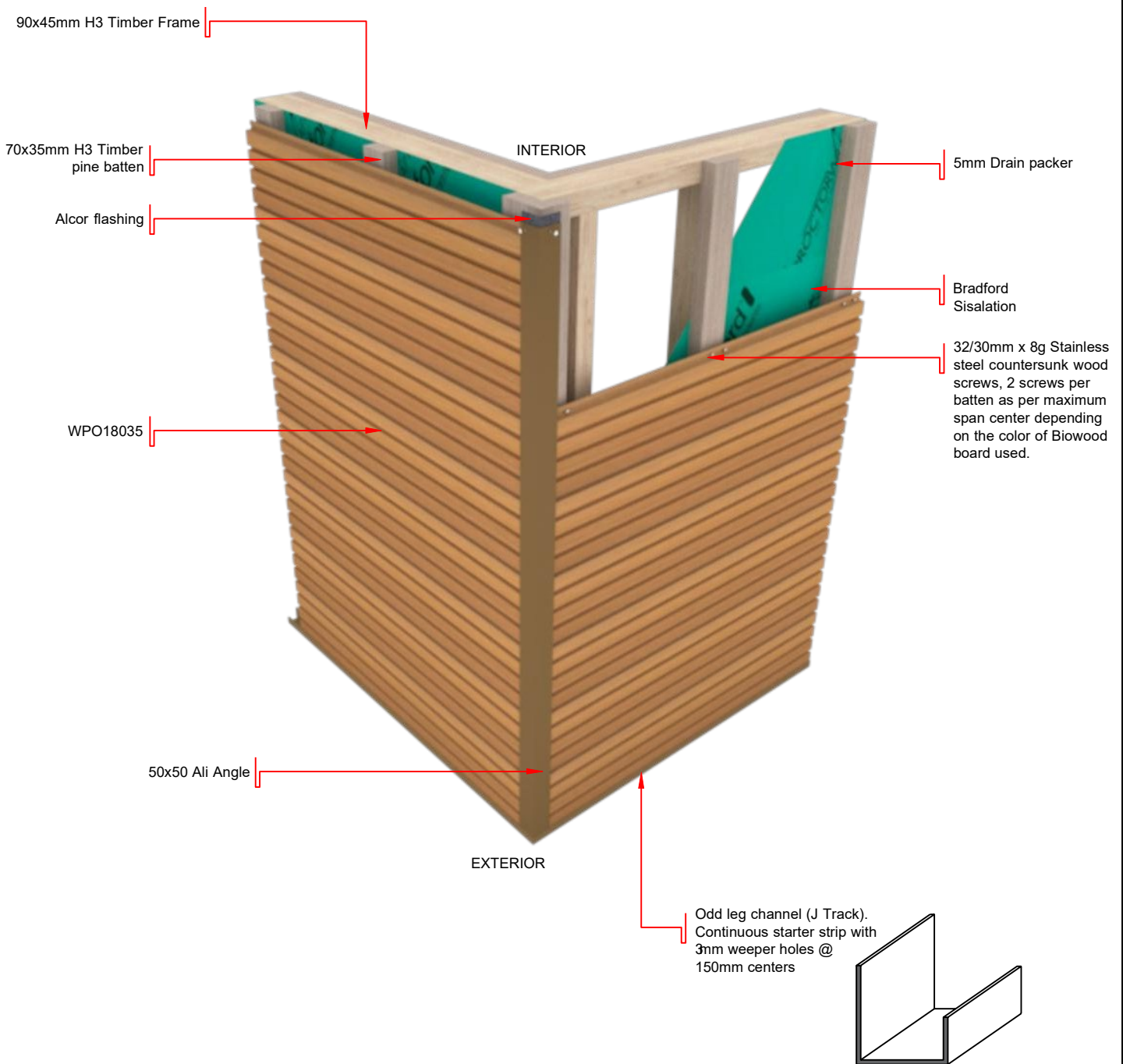

DWG - 01

ISOMETRIC VIEW OF EXTERIOR WALL DETAIL OF HORIZONTAL LAID BIOWOOD CLADDING - WPO18035

NOT TO SCALE

THE BIOWOOD CASTELLATED PROFILE CLADDING WPO18035 HORIZONTAL INSTALLATION MANUAL  
COPYRIGHT © GREEN RESOURCESS MATERIAL AUSTRALIA PTY LTD ALL RIGHTS RESERVED Feb 1, 2026-VERSION 2.2

- THESE DRAWINGS MUST BE READ IN CONJUNCTION WITH THE LIST OF SPECIFIED / ACCEPTED PRODUCTS SUPPLIED WITH THE BIOWOOD CASTELLATED (WEATHERBOARD) & CASTELLATED PROFILE CLADDING AND SOFFIT SYSTEMS TECHNICAL MANUAL.  
- SUBSTRATE TO BE PREPPED READY TO APPLY THE BIOWOOD CASTELLATED (WEATHERBOARD) & CASTELLATED PROFILE CLADDING TO. THIS MUST COMPLY WITH ALL RELEVANT STANDARDS AND REQUIREMENTS e.g. NZBC, GREEN RESOURCES MATERIALS AUSTRALIA PTY LTD AND OTHER PRODUCTS DETAILS.



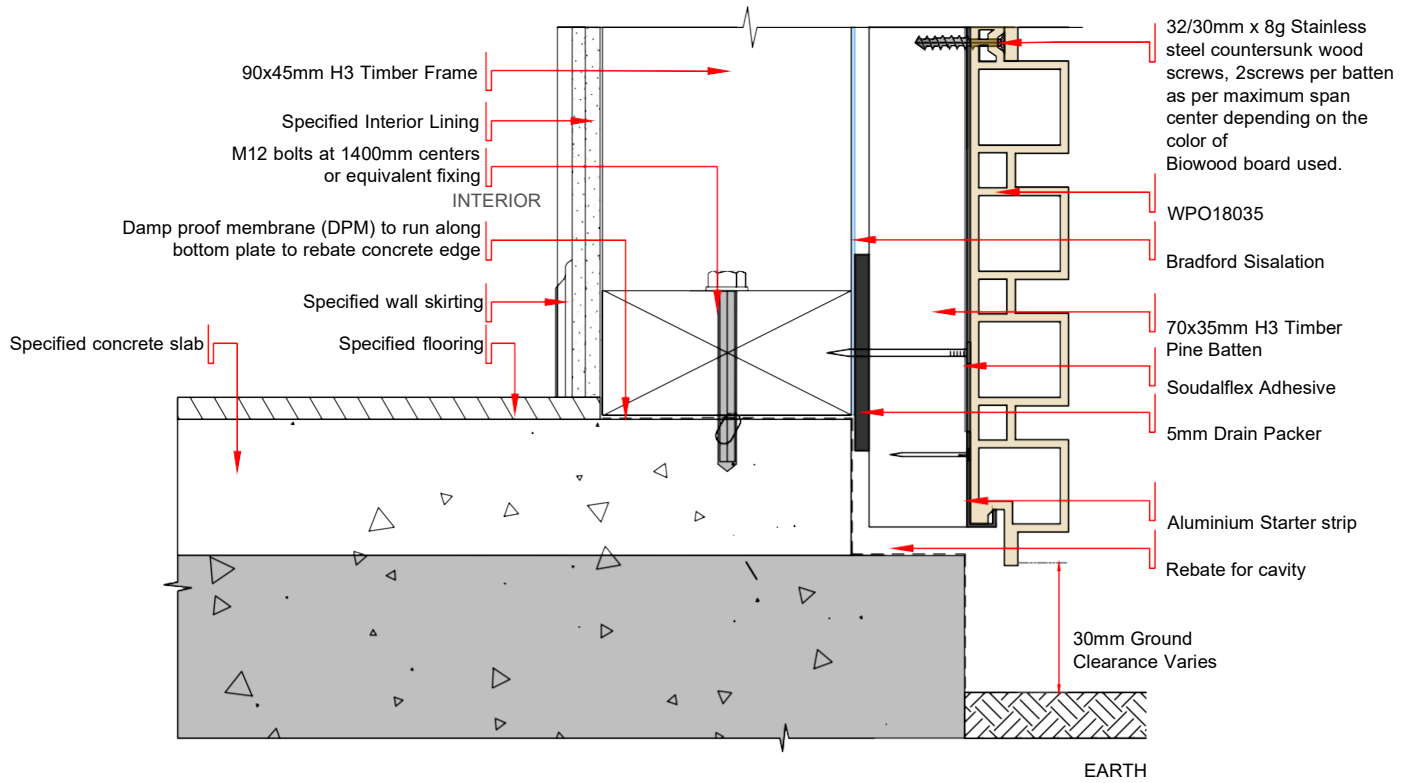

DWG - 02 SECTION VIEW OF REBATED EDGE SLAB EDGE DETAIL OF HORIZONTAL LAID BIOWOOD CLADDING - WPO18035 SCALE 1:2.5 @ A4

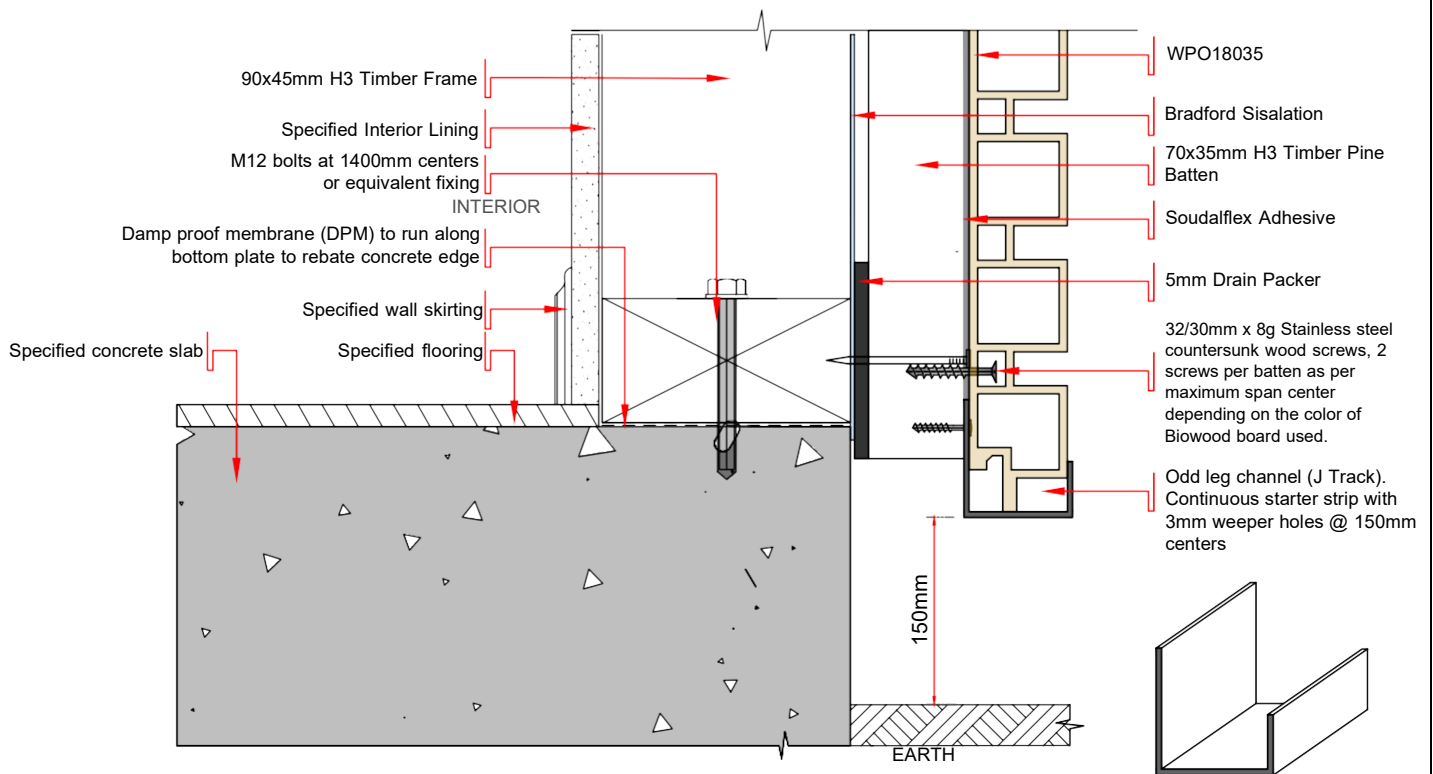

DWG - 03 SECTION VIEW OF CONCRETE EDGE SLAB EDGE DETAIL OF HORIZONTAL LAID BIOWOOD CLADDING - WPO18035 SCALE 1:2.5 @ A4

THE BIOWOOD CASTELLATED PROFILE CLADDING WPO18035 HORIZONTAL INSTALLATION MANUAL  
 COPYRIGHT © GREEN RESOURCESS MATERIAL AUSTRALIA PTY LTD ALL RIGHTS RESERVED Feb 1, 2026-VERSION 2.2

- THESE DRAWINGS MUST BE READ IN CONJUNCTION WITH THE LIST OF SPECIFIED / ACCEPTED PRODUCTS SUPPLIED WITH THE BIOWOOD CASTELLATED (WEATHERBOARD) & CASTELLATED PROFILE CLADDING AND SOFFIT SYSTEMS TECHNICAL MANUAL.  
 - SUBSTRATE TO BE PREPPED READY TO APPLY THE BIOWOOD CASTELLATED (WEATHERBOARD) & CASTELLATED PROFILE CLADDING TO. THIS MUST COMPLY WITH ALL RELEVANT STANDARDS AND REQUIREMENTS e.g. NZBC, GREEN RESOURCES MATERIALS AUSTRALIA PTY LTD AND OTHER PRODUCTS DETAILS.



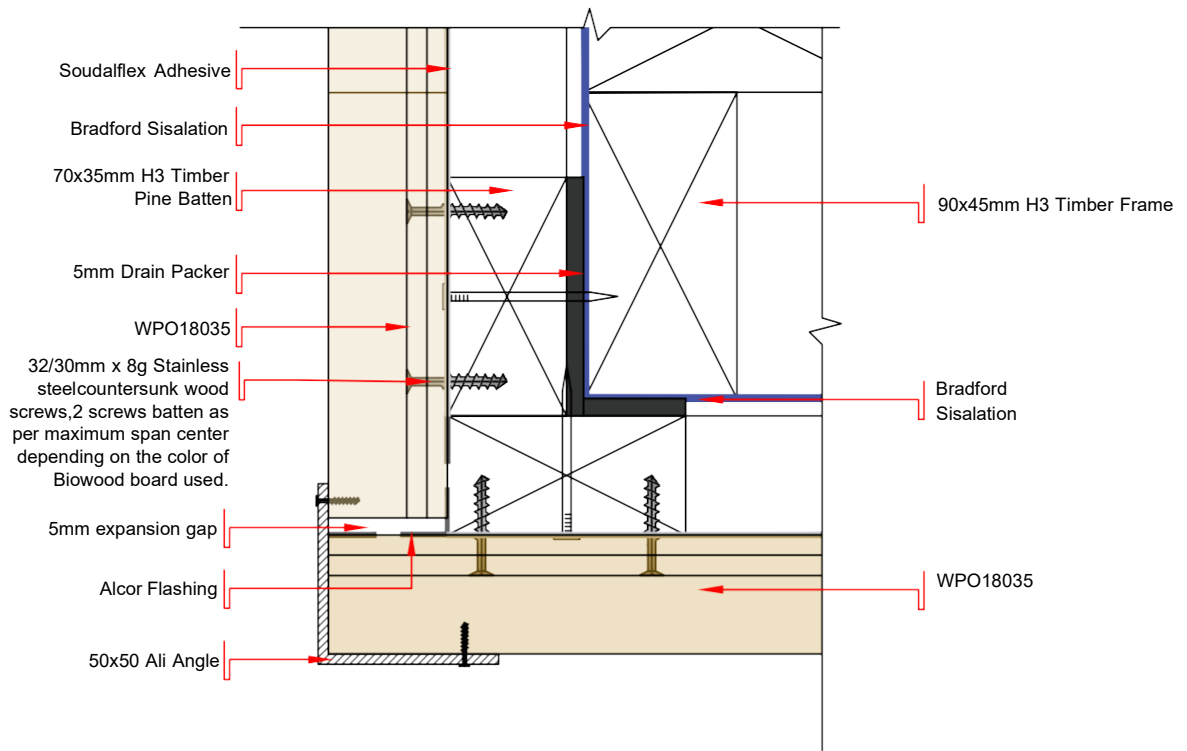

DWG - 04    PLAN VIEW OF EXTERNAL CORNER OPTION DETAIL OF HORIZONTAL LAID BIOWOOD CLADDING - WPO18035    SCALE 1:2.2 @ A4

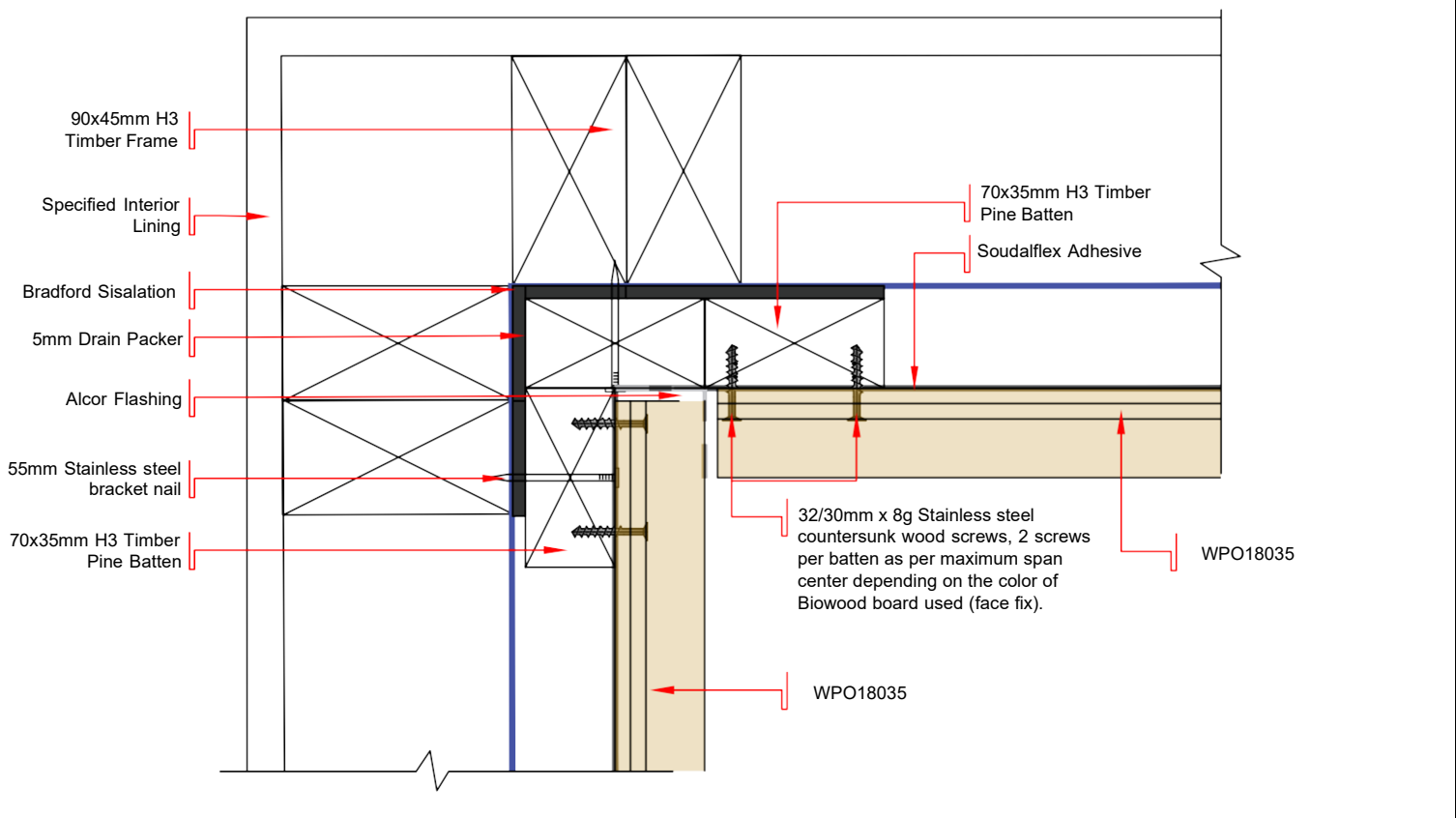

DWG - 05    PLAN VIEW OF INTERNAL CORNER DETAIL OF HORIZONTAL LAID BIOWOOD CLADDING - WPO18035    SCALE 1:3 @ A4

THE BIOWOOD CASTELLATED PROFILE CLADDING WPO18035 HORIZONTAL INSTALLATION MANUAL  
 COPYRIGHT © GREEN RESOURCESS MATERIAL AUSTRALIA PTY LTD ALL RIGHTS RESERVED Feb 1, 2026-VERSION 2.2

- THESE DRAWINGS MUST BE READ IN CONJUNCTION WITH THE LIST OF SPECIFIED / ACCEPTED PRODUCTS SUPPLIED WITH THE BIOWOOD CASTELLATED (WEATHERBOARD) & CASTELLATED PROFILE CLADDING AND SOFFIT SYSTEMS TECHNICAL MANUAL.  
 - SUBSTRATE TO BE PREPPED READY TO APPLY THE BIOWOOD CASTELLATED (WEATHERBOARD) & CASTELLATED PROFILE CLADDING TO. THIS MUST COMPLY WITH ALL RELEVANT STANDARDS AND REQUIREMENTS e.g. NZBC, GREEN RESOURCES MATERIALS AUSTRALIA PTY LTD AND OTHER PRODUCTS DETAILS.



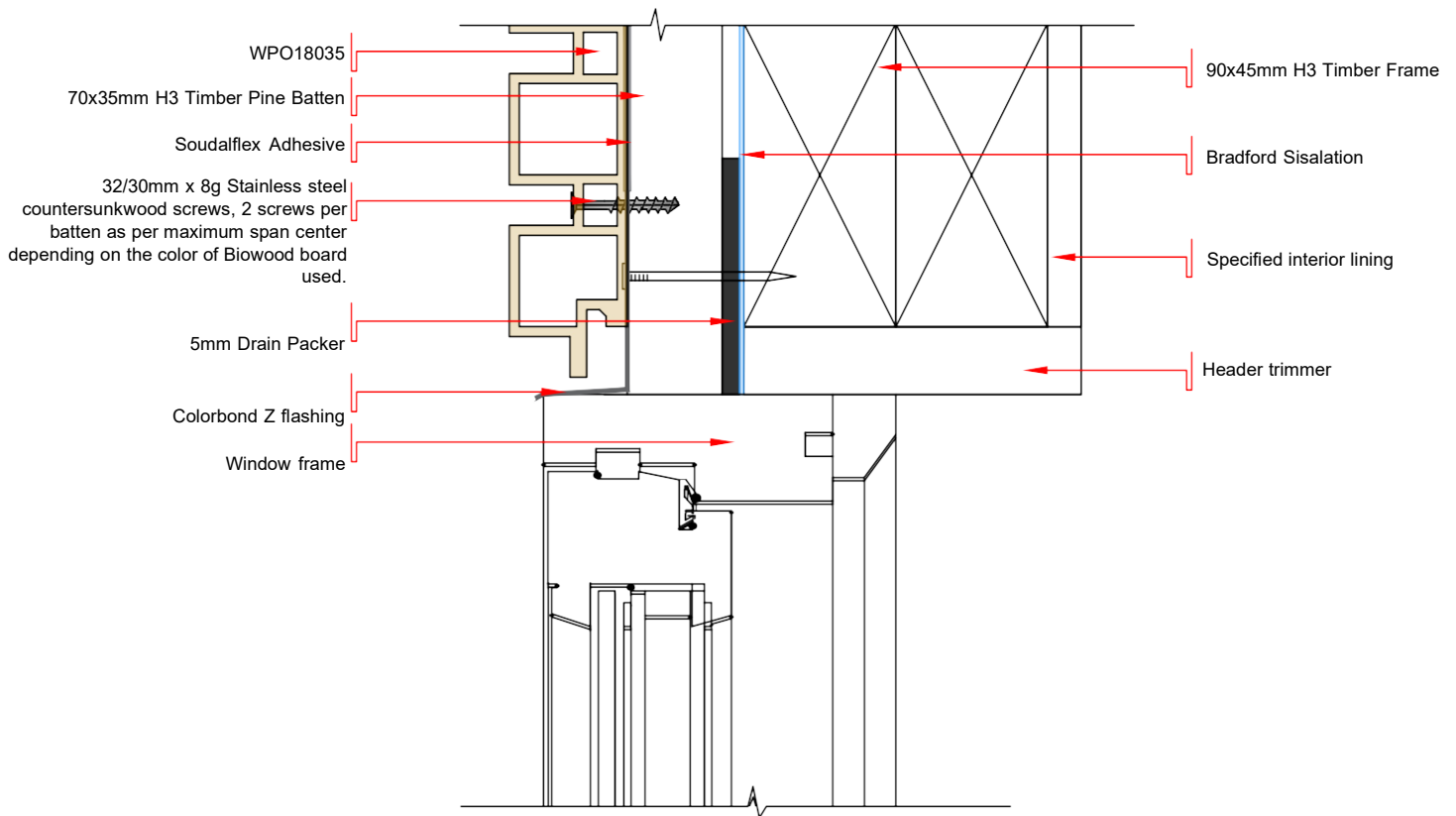

DWG - 06	SECTION VIEW OF WINDOW HEAD DETAIL OF HORIZONTAL LAID BIOWOOD CLADDING - WPO18035	SCALE 1:2.2 @ A4
----------	---	------------------

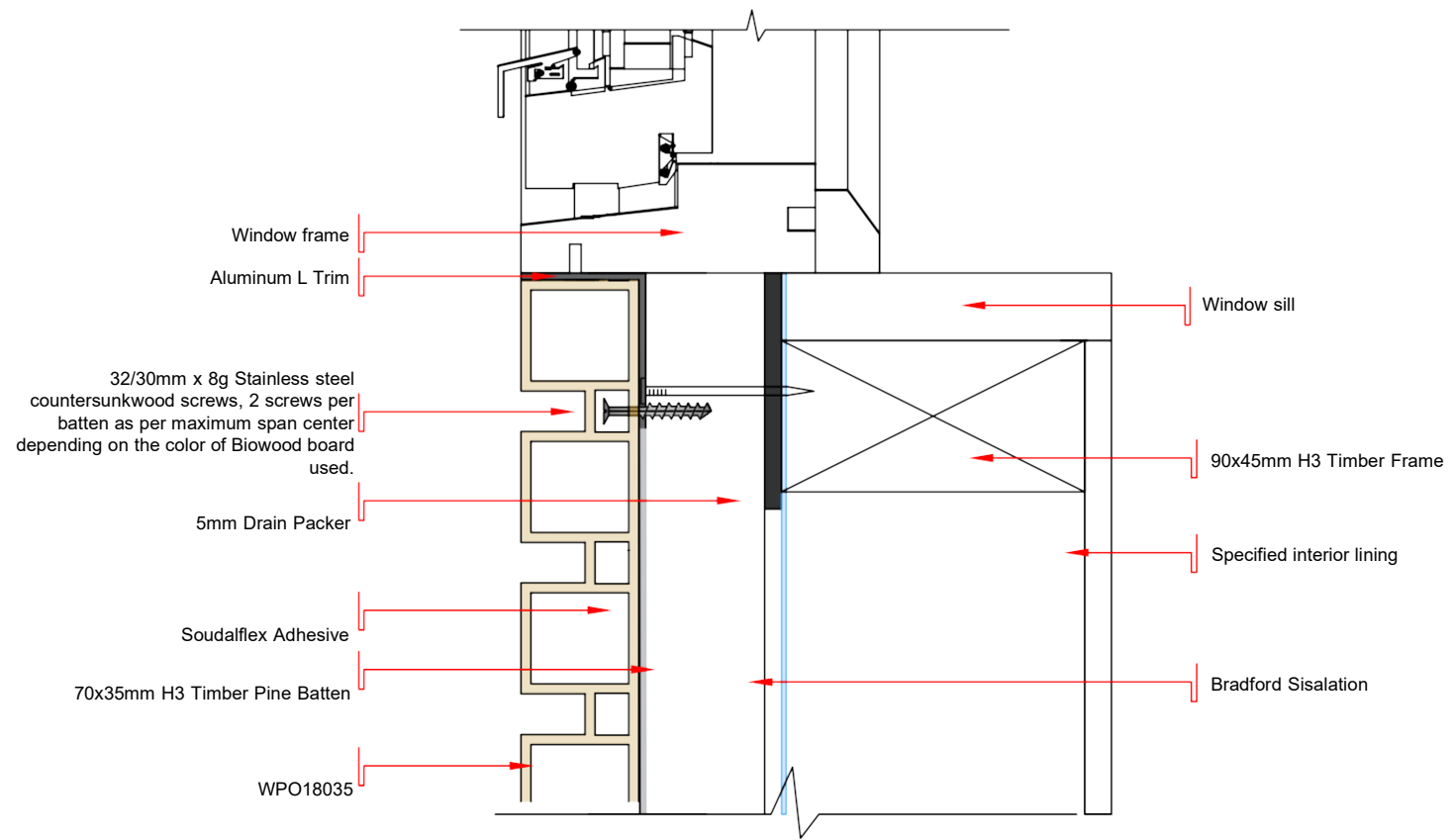

DWG - 07	SECTION VIEW OF WINDOW SILL DETAIL OF HORIZONTAL LAID BIOWOOD CLADDING - WPO18035	SCALE 1:2.2 @ A4
----------	---	------------------

THE BIOWOOD CASTELLATED PROFILE CLADDING WPO18035 HORIZONTAL INSTALLATION MANUAL  
 COPYRIGHT © GREEN RESOURCESS MATERIAL AUSTRALIA PTY LTD ALL RIGHTS RESERVED Feb 1, 2026-VERSION 2.2

- THESE DRAWINGS MUST BE READ IN CONJUNCTION WITH THE LIST OF SPECIFIED / ACCEPTED PRODUCTS SUPPLIED WITH THE BIOWOOD CASTELLATED (WEATHERBOARD) & CASTELLATED PROFILE CLADDING AND SOFFIT SYSTEMS TECHNICAL MANUAL.  
 - SUBSTRATE TO BE PREPPED READY TO APPLY THE BIOWOOD CASTELLATED (WEATHERBOARD) & CASTELLATED PROFILE CLADDING TO. THIS MUST COMPLY WITH ALL RELEVANT STANDARDS AND REQUIREMENTS e.g. NZBC, GREEN RESOURCES MATERIALS AUSTRALIA PTY LTD AND OTHER PRODUCTS DETAILS.



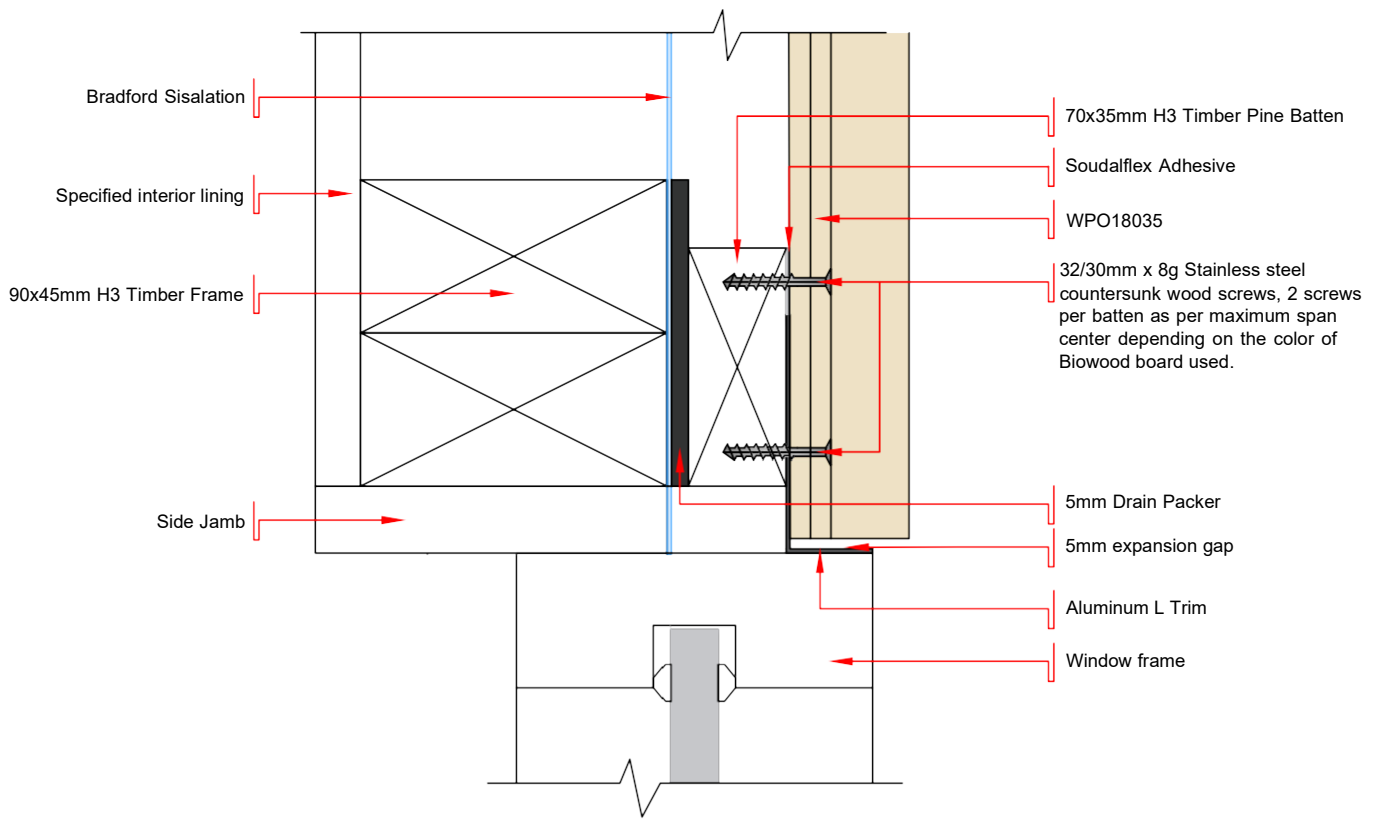

DWG - 08

PLAN VIEW OF WINDOW JAMB DETAIL OF HORIZONTAL LAID BIOWOOD CLADDING - WPO18035

SCALE 1:2.2 @ A4

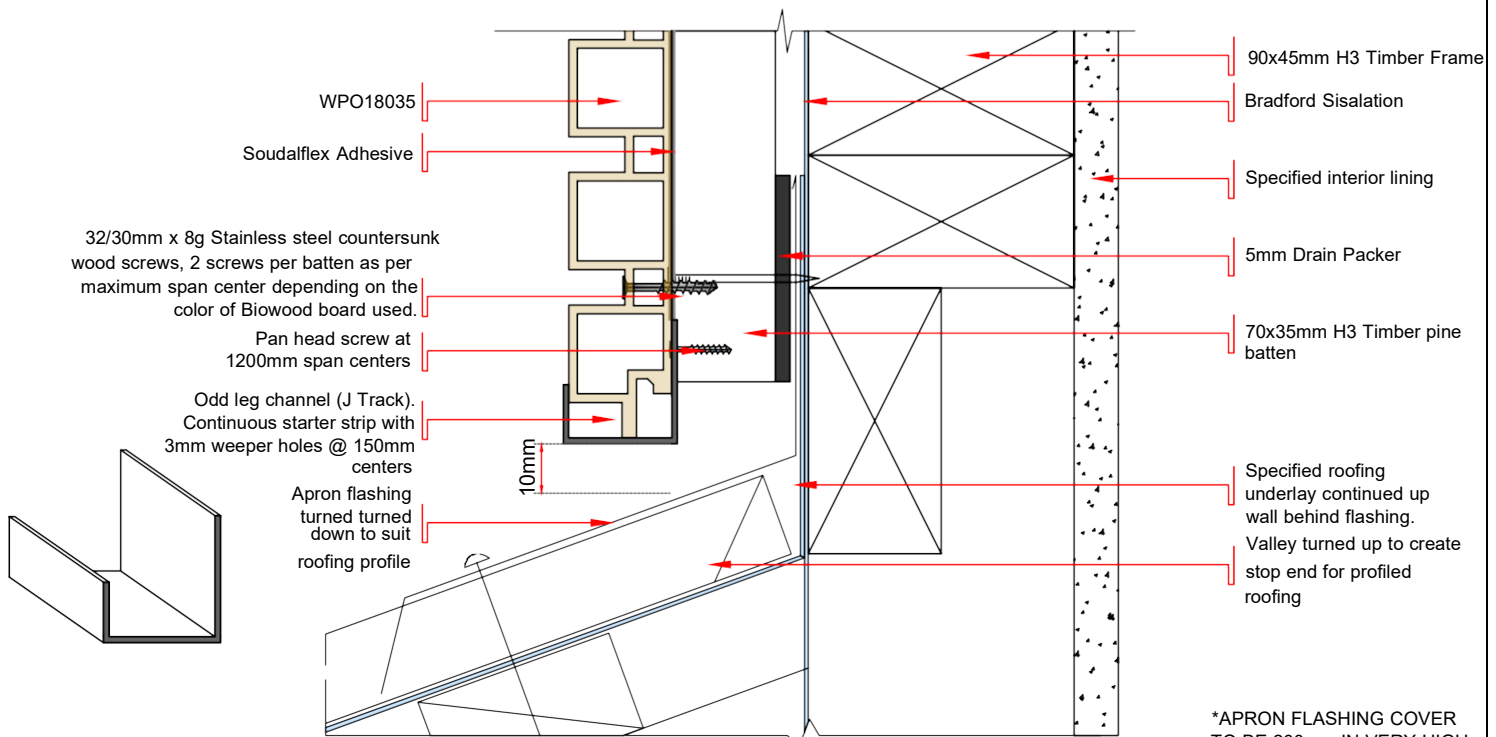

\*APRON FLASHING COVER TO BE 200mm IN VERY HIGH OR ABOVE WIND ZONES OR ROOF PITCHES<11°

DWG - 09

SECTION VIEW OF TRANSVERSE APRON DETAIL OF HORIZONTAL LAID BIOWOOD CLADDING - WPO18035

SCALE 1:2.5 @ A4

THE BIOWOOD CASTELLATED PROFILE CLADDING WPO18035 HORIZONTAL INSTALLATION MANUAL  
 COPYRIGHT © GREEN RESOURCESS MATERIAL AUSTRALIA PTY LTD ALL RIGHTS RESERVED Feb 1, 2026-VERSION 2.2

- THESE DRAWINGS MUST BE READ IN CONJUNCTION WITH THE LIST OF SPECIFIED / ACCEPTED PRODUCTS SUPPLIED WITH THE BIOWOOD CASTELLATED (WEATHERBOARD) & CASTELLATED PROFILE CLADDING AND SOFFIT SYSTEMS TECHNICAL MANUAL.  
 - SUBSTRATE TO BE PREPPED READY TO APPLY THE BIOWOOD CASTELLATED (WEATHERBOARD) & CASTELLATED PROFILE CLADDING TO. THIS MUST COMPLY WITH ALL RELEVANT STANDARDS AND REQUIREMENTS e.g. NZBC, GREEN RESOURCES MATERIALS AUSTRALIA PTY LTD AND OTHER PRODUCTS DETAILS.



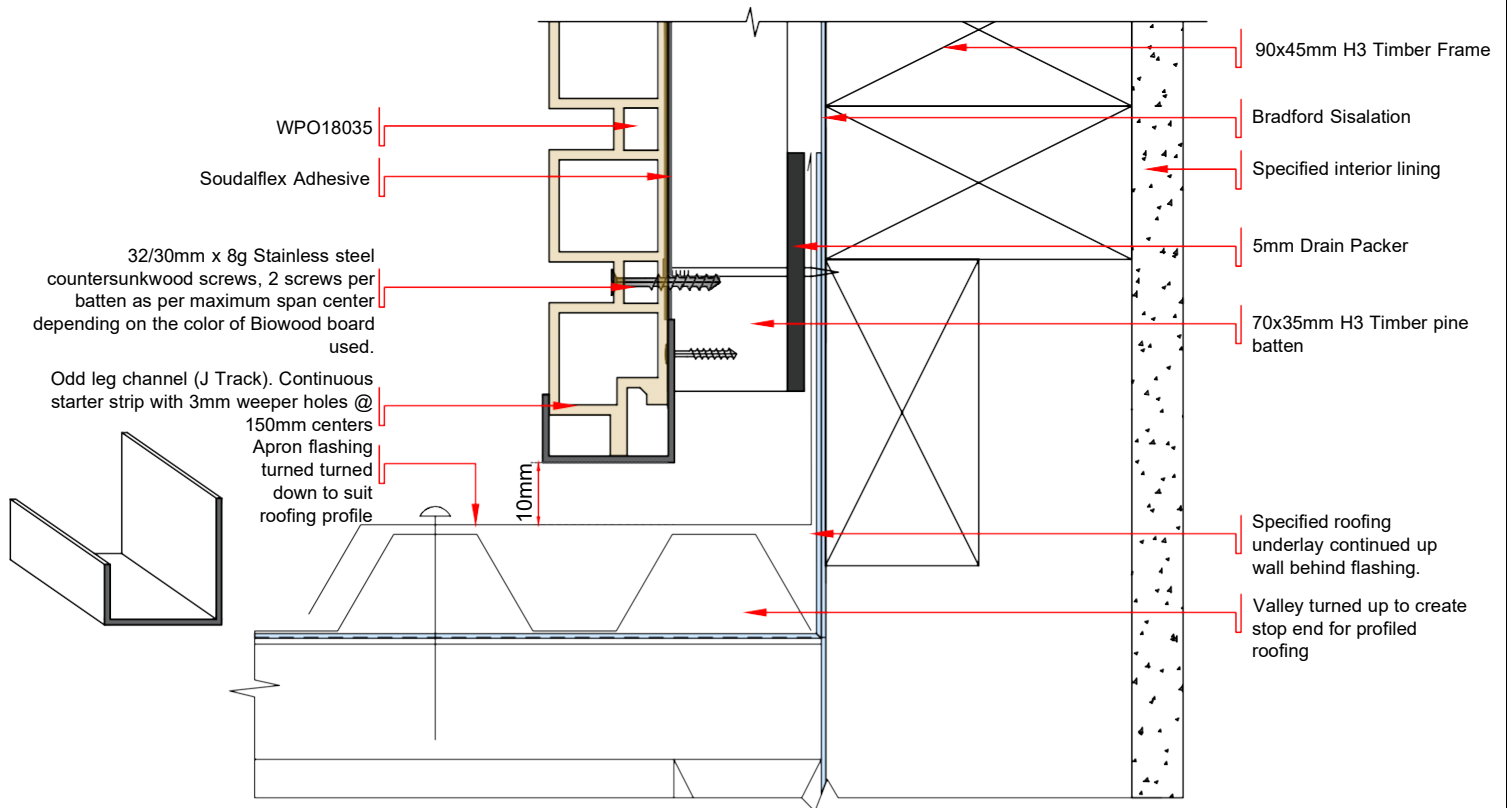

DWG - 10 SECTION VIEW OF PARALLEL APRON DETAIL OF HORIZONTAL LAID BIOWOOD CLADDING - WPO18035 SCALE 1:2.2 @ A4

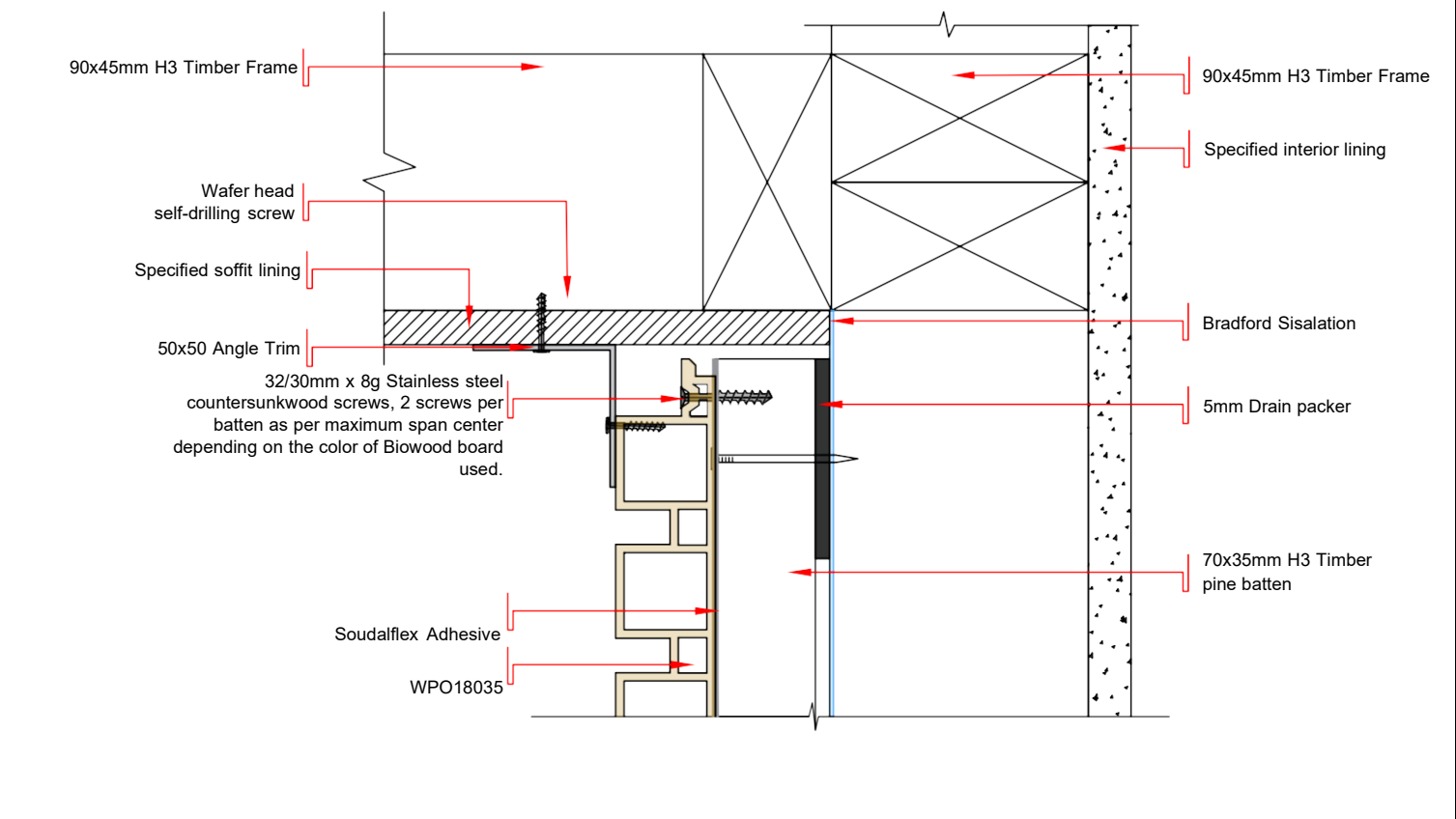

DWG - 11 SECTION VIEW OF CLADDING TO SOFFIT DETAIL OF HORIZONTAL LAID BIOWOOD CLADDING - WPO18035 SCALE 1:2.5 @ A4

THE BIOWOOD CASTELLATED PROFILE CLADDING WPO18035 HORIZONTAL INSTALLATION MANUAL  
 COPYRIGHT © GREEN RESOURCESS MATERIAL AUSTRALIA PTY LTD ALL RIGHTS RESERVED Feb 1, 2026-VERSION 2.2

- THESE DRAWINGS MUST BE READ IN CONJUNCTION WITH THE LIST OF SPECIFIED / ACCEPTED PRODUCTS SUPPLIED WITH THE BIOWOOD CASTELLATED (WEATHERBOARD) & CASTELLATED PROFILE CLADDING AND SOFFIT SYSTEMS TECHNICAL MANUAL.  
 - SUBSTRATE TO BE PREPPED READY TO APPLY THE BIOWOOD CASTELLATED (WEATHERBOARD) & CASTELLATED PROFILE CLADDING TO. THIS MUST COMPLY WITH ALL RELEVANT STANDARDS AND REQUIREMENTS e.g. NZBC, GREEN RESOURCES MATERIALS AUSTRALIA PTY LTD AND OTHER PRODUCTS DETAILS.



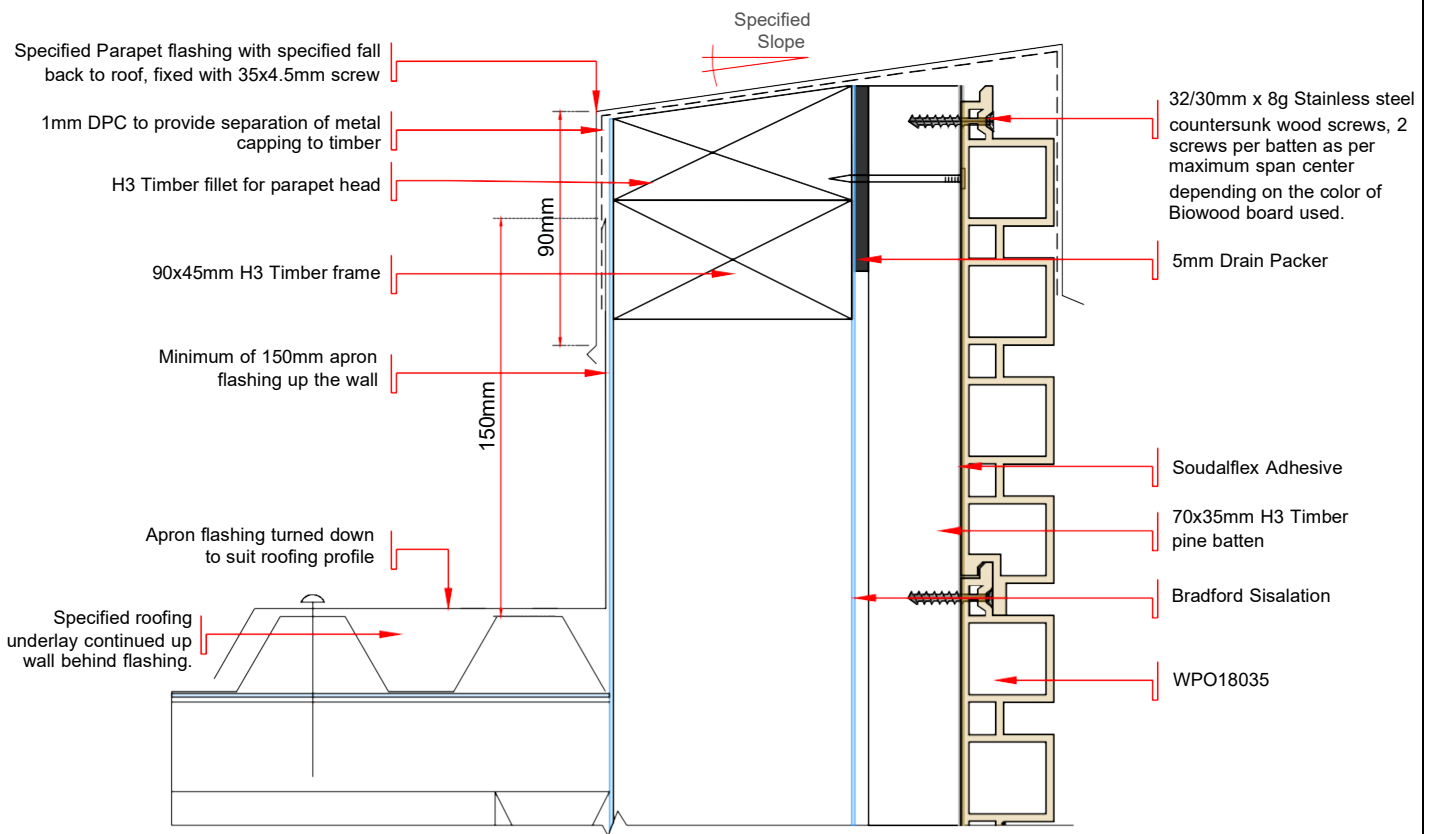

DWG - 12 SECTION VIEW OF PARAPET TO ROOF JUNCTION DETAIL OF HORIZONTAL LAID BIOWOOD CLADDING - WPO18035 SCALE 1:3 @ A4

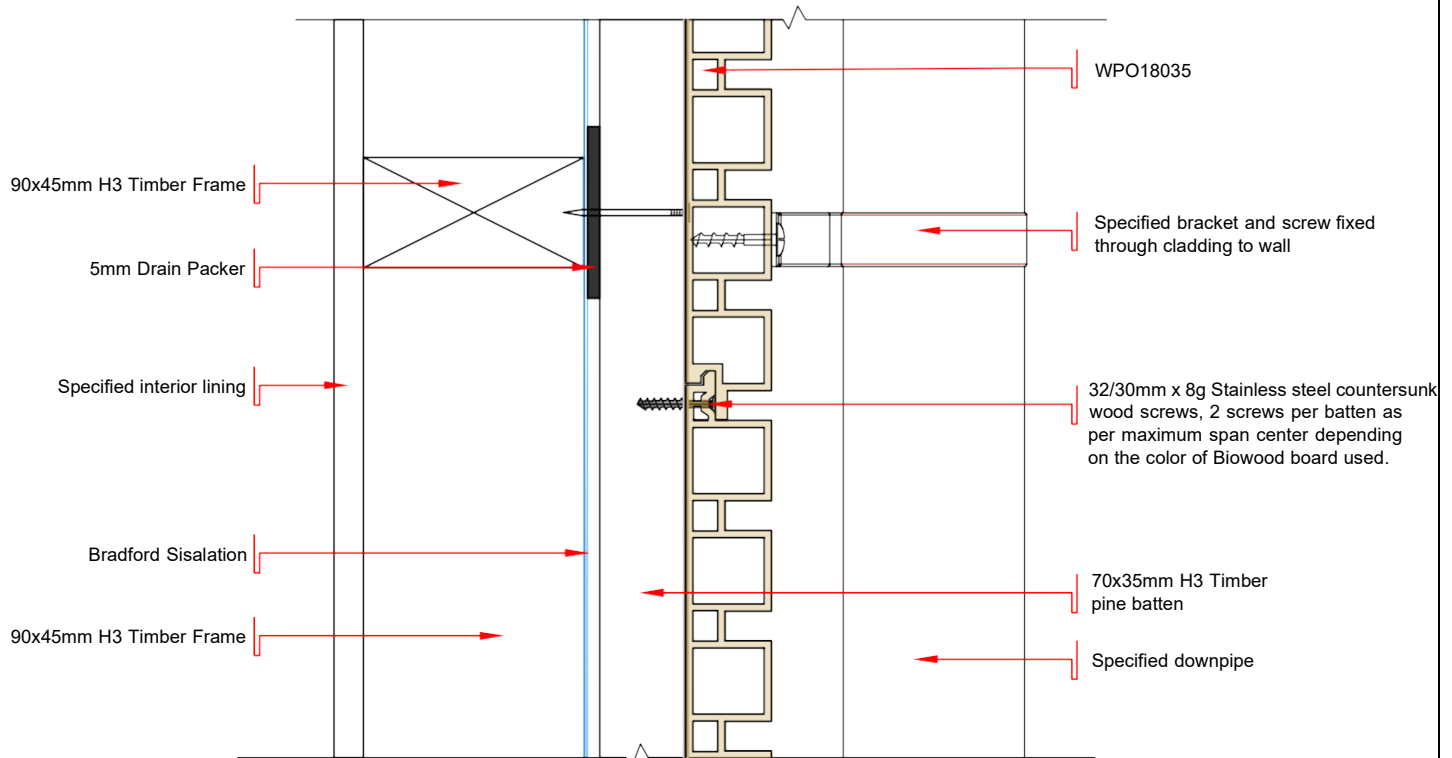

DWG - 13 SECTION VIEW OF DOWNPIPE FIXING DETAIL OF HORIZONTAL LAID BIOWOOD CLADDING - WPO18035 SCALE 1:3 @ A4

THE BIOWOOD CASTELLATED PROFILE CLADDING WPO18035 HORIZONTAL INSTALLATION MANUAL  
 COPYRIGHT © GREEN RESOURCESS MATERIAL AUSTRALIA PTY LTD ALL RIGHTS RESERVED Feb 1, 2026-VERSION 2.2

- THESE DRAWINGS MUST BE READ IN CONJUNCTION WITH THE LIST OF SPECIFIED / ACCEPTED PRODUCTS SUPPLIED WITH THE BIOWOOD CASTELLATED (WEATHERBOARD) & CASTELLATED PROFILE CLADDING AND SOFFIT SYSTEMS TECHNICAL MANUAL.  
 - SUBSTRATE TO BE PREPPED READY TO APPLY THE BIOWOOD CASTELLATED (WEATHERBOARD) & CASTELLATED PROFILE CLADDING TO. THIS MUST COMPLY WITH ALL RELEVANT STANDARDS AND REQUIREMENTS e.g. NZBC, GREEN RESOURCES MATERIALS AUSTRALIA PTY LTD AND OTHER PRODUCTS DETAILS.



# Appendix B

## STUDCO TOP HAT SPAN TABLES (FOR BIOWOOD PANELS)

### Design Notes:

1. Seismic was not specified or considered in this design.
2. Framing design complies with AS/NZ1170 (Part 0, 1, 2)
3. Cladding deflection limit = Span / 360
4. Span tables in this document is applicable for Biowood panels only.  
Biowood panel code as following: WPO15018, WPO18518, WPO20018, WPO25018, WPO60018, WPO18025A, WPO18035, WPO18033, WPO25028 & WPO30060
5. Cladding weight = 30 kg/m<sup>2</sup> Max

Part No.	A	B	C
JS5050115	50	50	20
JS12035115	120	35	
JS5015115	50	15	
JS5025115	50	25	
JS5035115	50	35	

**DIMENSION CHART**

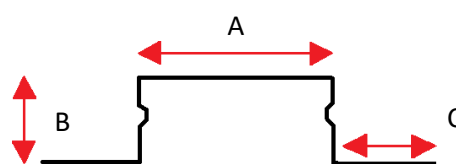

Dimensions are in millimeters

### JS5050115

Design Wind Pressure kPa		Single Span		Double Span		Three Spans	
		Top Hat Spacing mm		Top Hat Spacing mm		Top Hat Spacing mm	
		400	600	400	600	400	600
SER	ULT	MAXIMUM SPAN OF TOP HAT PROFILE (mm)					
0.53	0.75	2450	2200	3200	2950	3000	2750
0.70	1.0	2200	2000	2900	2700	2700	2500
1.05	1.50	1900	1750	2600	2350	2400	2100
1.40	2.0	1750	1600	2300	2150	2150	1950
1.75	2.5	1600	1450	2200	2000	2000	1800
2.10	3.0	1500	1400	2000	1900	1900	1700
2.80	4.0	1400	1250	1850	1700	1700	1550

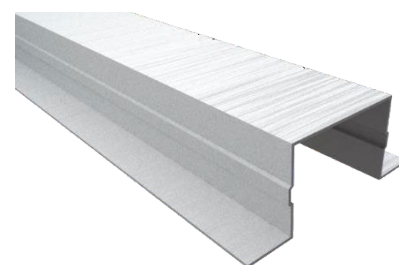

### JS12035115

Design Wind Pressure kPa		Single Span		Double Span		Three Spans	
		Top Hat Spacing mm		Top Hat Spacing mm		Top Hat Spacing mm	
		400	600	400	600	400	600
SER	ULT	MAXIMUM SPAN OF TOP HAT PROFILE (mm)					
0.53	0.75	2050	1800	2700	2500	2500	2300
0.70	1.0	1850	1700	2500	2250	2300	2100
1.05	1.50	1600	1450	2200	2000	2000	1800
1.40	2.0	1450	1350	2000	1800	1800	1650
1.75	2.5	1350	1250	1850	1650	1700	1550
2.10	3.0	1300	1150	1700	1550	1600	1450
2.80	4.0	1150	1050	1550	1400	1450	1300

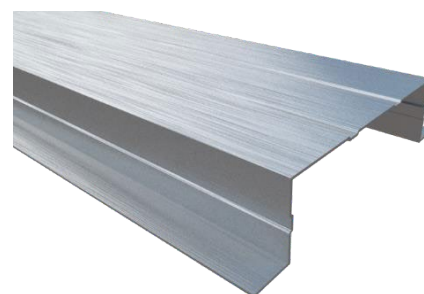

### JS5015115

Design Wind Pressure kPa		Single Span		Double Span		Three Spans	
		Top Hat Spacing mm		Top Hat Spacing mm		Top Hat Spacing mm	
		400	600	400	600	400	600
SER	ULT	MAXIMUM SPAN OF TOP HAT PROFILE (mm)					
0.53	0.75	950	850	1300	1150	NA	
0.70	1.0	850	800	1150	1050		
1.05	1.50	750	700	1000	900		
1.40	2.0	700	630	900	850		
1.75	2.5	650	600	850	800		
2.10	3.0	600	550	800	750		
2.80	4.0	550	500	750	650		



### JS5025115

Design Wind Pressure kPa		Single Span		Double Span		Three Spans	
		Top Hat Spacing mm		Top Hat Spacing mm		Top Hat Spacing mm	
		400	600	400	600	400	600
SER	ULT	MAXIMUM SPAN OF TOP HAT PROFILE (mm)					
0.53	0.75	1400	1250	1900	1750	NA	
0.70	1.0	1250	1150	1750	1600		
1.05	1.50	1100	1000	1500	1400		
1.40	2.0	1000	900	1400	1250		
1.75	2.5	950	850	1300	1150		
2.10	3.0	900	800	1200	1100		
2.80	4.0	800	700	1100	1000		



### JS5035115

Design Wind Pressure kPa		Single Span		Double Span		Three Spans	
		Top Hat Spacing mm		Top Hat Spacing mm		Top Hat Spacing mm	
SER	ULT	MAXIMUM SPAN OF TOP HAT PROFILE (mm)					
0.53	0.75	1850	1650	2300	2100	NA	
0.70	1.0	1650	1500	2150	1950		
1.05	1.50	1450	1300	1900	1750		
1.40	2.0	1300	1200	1750	1600		
1.75	2.5	1200	1100	1600	1450		
2.10	3.0	1100	1000	1500	1400		
2.80	4.0	1050	950	1400	1200		

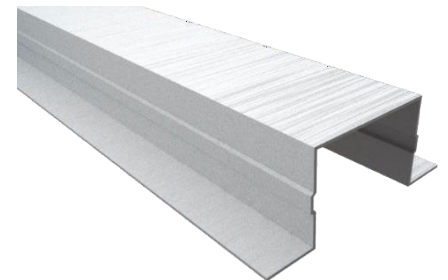

## SETTING OUT

Inspect plan and site measurements prior to installation. Substrate straightness must be checked for Biowood boards will follow any unevenness against battens. Boards should be set out depending on the width to minimize waste and butt joints. In circumstances where sarking is present, double battening of STUDCO Top Hat frames is recommended to ensure adequate adhesion between Biowood and the substrate.

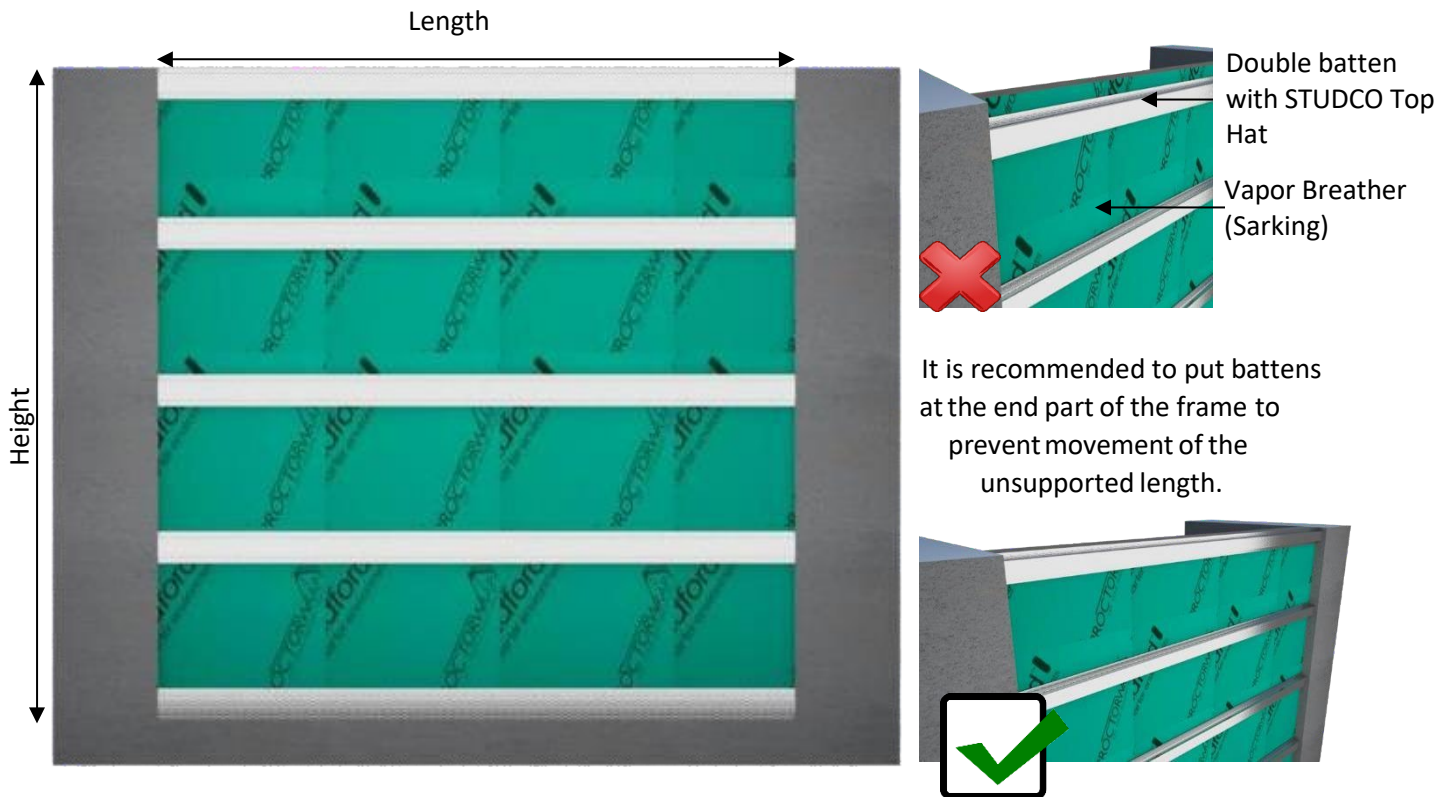

## Recommended Span Centers & Application on Sarking

Maximum span center of 450mm battens spacing: Spotted Gum, Natural Oak, Western Red Cedar and Driftwood.

**Maximum span center of 300mm batten spacing: Black Japan, Weatherwood, Charred Wood and Deep Walnut.**

**Glue and two screws procedure are not applicable to be directly applied to sarking; double battening is recommended.**

## BUTT JOINTS AND CONTROL JOINTS

Biowood will expand and contract in length due to weather conditions. Although this movement will be minor, it is important to make allowances in your design to accommodate this movement. At each end of every board an expansion gap must be allowed of widths varying from a minimum of 3mm to a maximum of 6mm, see below Tables 1 and 2.

### Single boards run expansion gaps

Board length	Gap at each end
1000mm to 3000mm	3mm
3001mm to 4500mm	4mm
4501mm to 5850mm	5mm

## Multiple board run expansion gap

Maximum board length	Gap at butt joint
5850mm	6mm

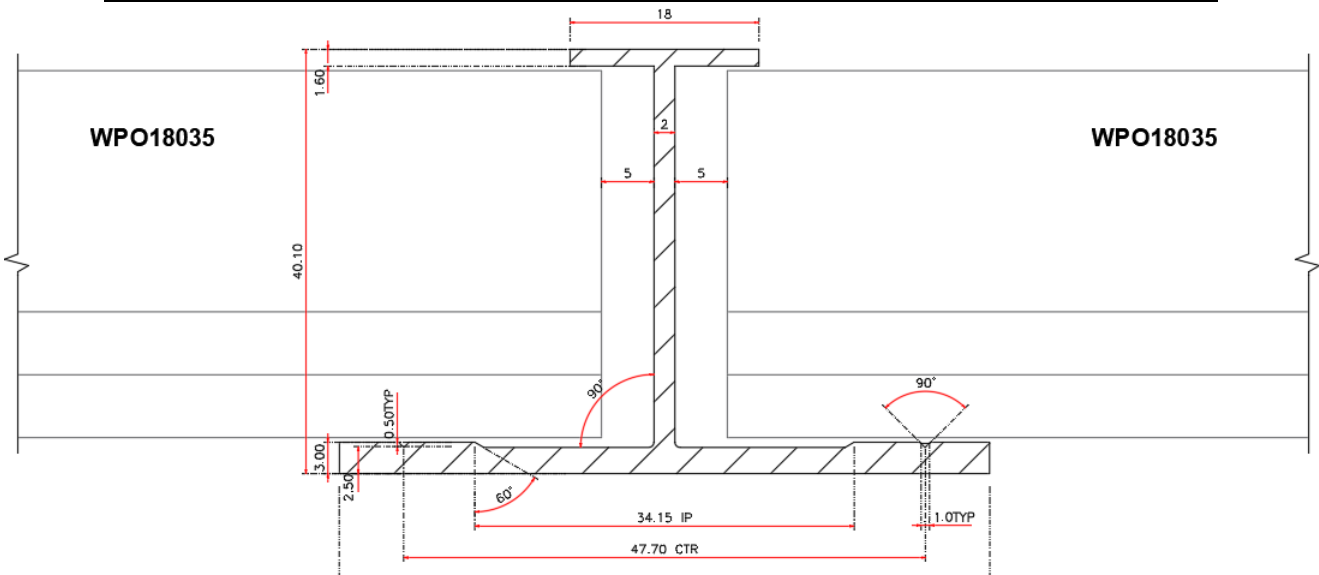

H Mould 20 mm face lips are used to conceal the joints between two boards, allowing 5mm clearance in lengthways only

### ACCEPTABLE TOLERANCE

	Cupping: 3mm across 180mm width
	Edge bowing: 10mm over the entire length of 5850mm
	Bowling: 15mm along the entire length of 5850mm

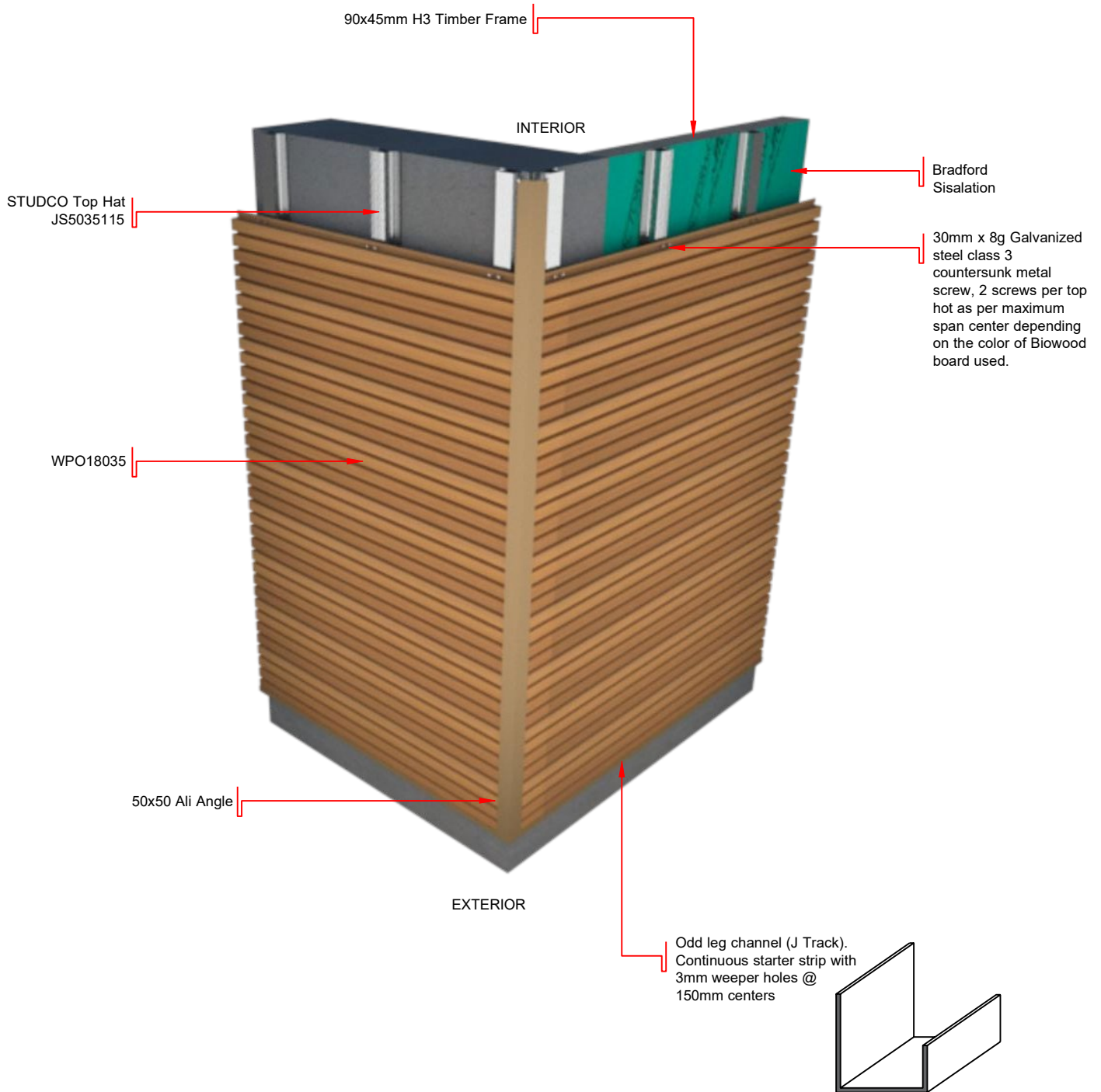

DWG - 01	ISOMETRIC VIEW OF EXTERIOR WALL DETAIL OF HORIZONTAL LAID BIOWOOD CLADDING - WPO18035	NOT TO SCALE
----------	---	--------------

THE BIOWOOD CASTELLATED PROFILE CLADDING WPO18035 HORIZONTAL INSTALLATION MANUAL  
 COPYRIGHT © GREEN RESOURCES MATERIAL AUSTRALIA PTY LTD ALL RIGHTS RESERVED Feb 1, 2026-VERSION 2.2

- THESE DRAWINGS MUST BE READ IN CONJUNCTION WITH THE LIST OF SPECIFIED / ACCEPTED PRODUCTS SUPPLIED WITH THE BIOWOOD CASTELLATED (WEATHERBOARD) & CASTELLATED PROFILE CLADDING AND SOFFIT SYSTEMS TECHNICAL MANUAL.
- SUBSTRATE TO BE PREPPED READY TO APPLY THE BIOWOOD CASTELLATED (WEATHERBOARD) & CASTELLATED PROFILE CLADDING TO. THIS MUST COMPLY WITH ALL RELEVANT STANDARDS AND REQUIREMENTS e.g. NZBC, GREEN RESOURCES MATERIALS AUSTRALIA PTY LTD AND OTHER PRODUCT DETAILS.



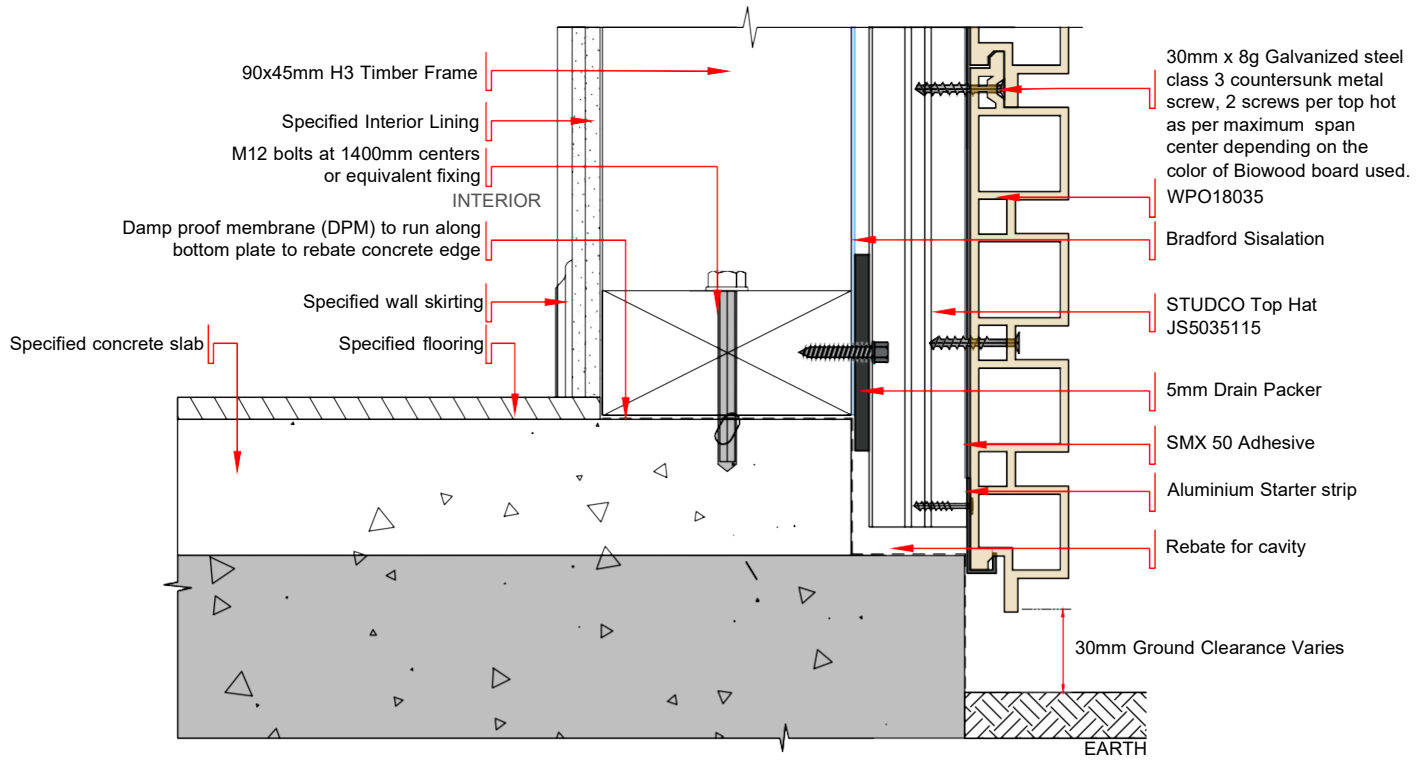

DWG - 02 SECTION VIEW OF REBATED EDGE SLAB EDGE DETAIL OF HORIZONTAL LAID BIOWOOD CLADDING - WPO18035 SCALE 1:2.5 @ A4

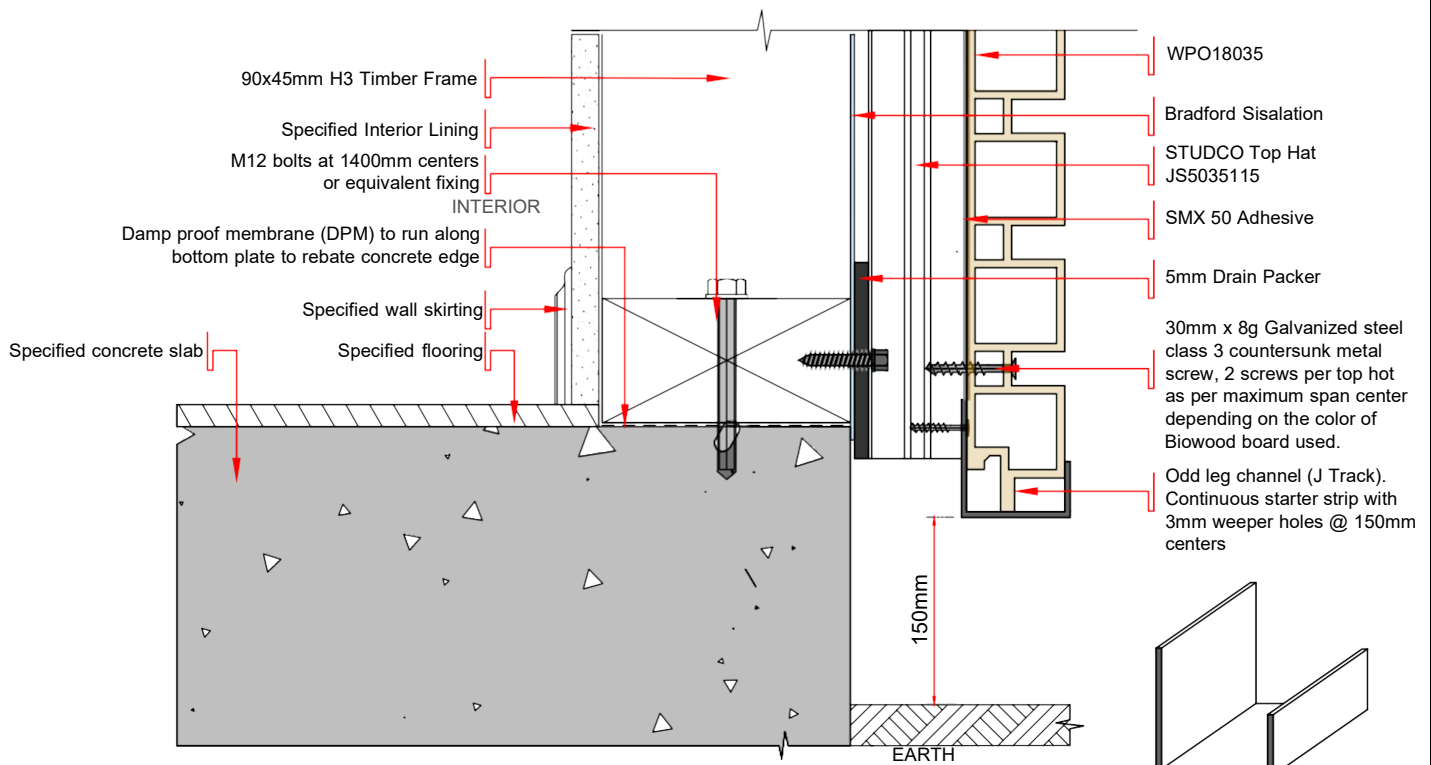

DWG - 03 SECTION VIEW OF CONCRETE EDGE SLAB EDGE DETAIL OF HORIZONTAL LAID BIOWOOD CLADDING - WPO18035 SCALE 1:2.5 @ A4

THE BIOWOOD CASTELLATED PROFILE CLADDING WPO18035 HORIZONTAL INSTALLATION MANUAL  
 COPYRIGHT © GREEN RESOURCES MATERIAL AUSTRALIA PTY LTD ALL RIGHTS RESERVED Feb 1, 2026-VERSION 2.2

- THESE DRAWINGS MUST BE READ IN CONJUNCTION WITH THE LIST OF SPECIFIED / ACCEPTED PRODUCTS SUPPLIED WITH THE BIOWOOD CASTELLATED (WEATHERBOARD) & CASTELLATED PROFILE CLADDING AND SOFFIT SYSTEMS TECHNICAL MANUAL.
- SUBSTRATE TO BE PREPPED READY TO APPLY THE BIOWOOD CASTELLATED (WEATHERBOARD) & CASTELLATED PROFILE CLADDING TO. THIS MUST COMPLY WITH ALL RELEVANT STANDARDS AND REQUIREMENTS e.g. NZBC, GREEN RESOURCES MATERIALS AUSTRALIA PTY LTD AND OTHER PRODUCT DETAILS.



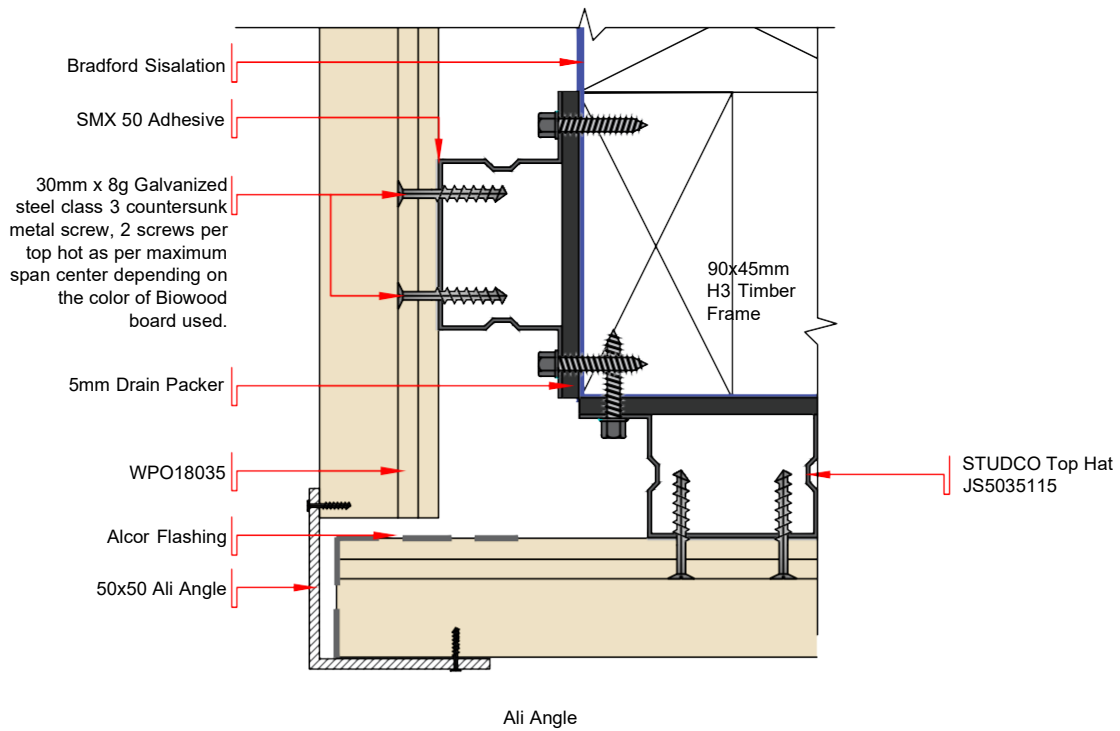

DWG - 04

PLAN VIEW OF EXTERNAL CORNER DETAIL OF HORIZONTAL LAID BIOWOOD CLADDING - WPO18035

SCALE 1:2.2 @ A4

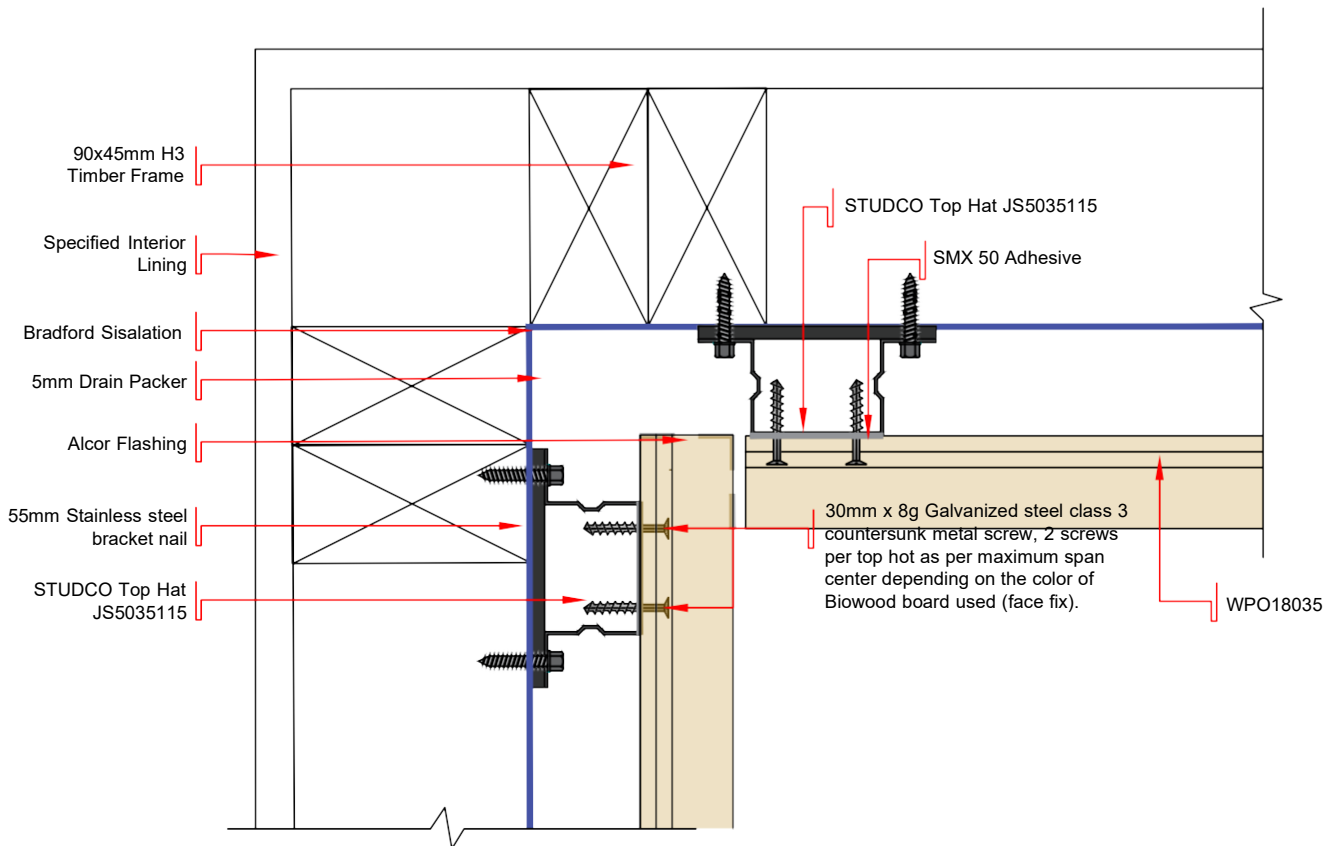

DWG - 05

PLAN VIEW OF INTERNAL CORNER DETAIL OF HORIZONTAL LAID BIOWOOD CLADDING - WPO18035

SCALE 1:3 @ A4

THE BIOWOOD CASTELLATED PROFILE CLADDING WPO18035 HORIZONTAL INSTALLATION MANUAL  
 COPYRIGHT © GREEN RESOURCES MATERIAL AUSTRALIA PTY LTD ALL RIGHTS RESERVED Feb 1, 2026-VERSION 2.2

- THESE DRAWINGS MUST BE READ IN CONJUNCTION WITH THE LIST OF SPECIFIED / ACCEPTED PRODUCTS SUPPLIED WITH THE BIOWOOD CASTELLATED (WEATHERBOARD) & CASTELLATED PROFILE CLADDING AND SOFFIT SYSTEMS TECHNICAL MANUAL.
- SUBSTRATE TO BE PREPPED READY TO APPLY THE BIOWOOD CASTELLATED (WEATHERBOARD) & CASTELLATED PROFILE CLADDING TO. THIS MUST COMPLY WITH ALL RELEVANT STANDARDS AND REQUIREMENTS e.g. NZBC, GREEN RESOURCES MATERIALS AUSTRALIA PTY LTD AND OTHER PRODUCT DETAILS.



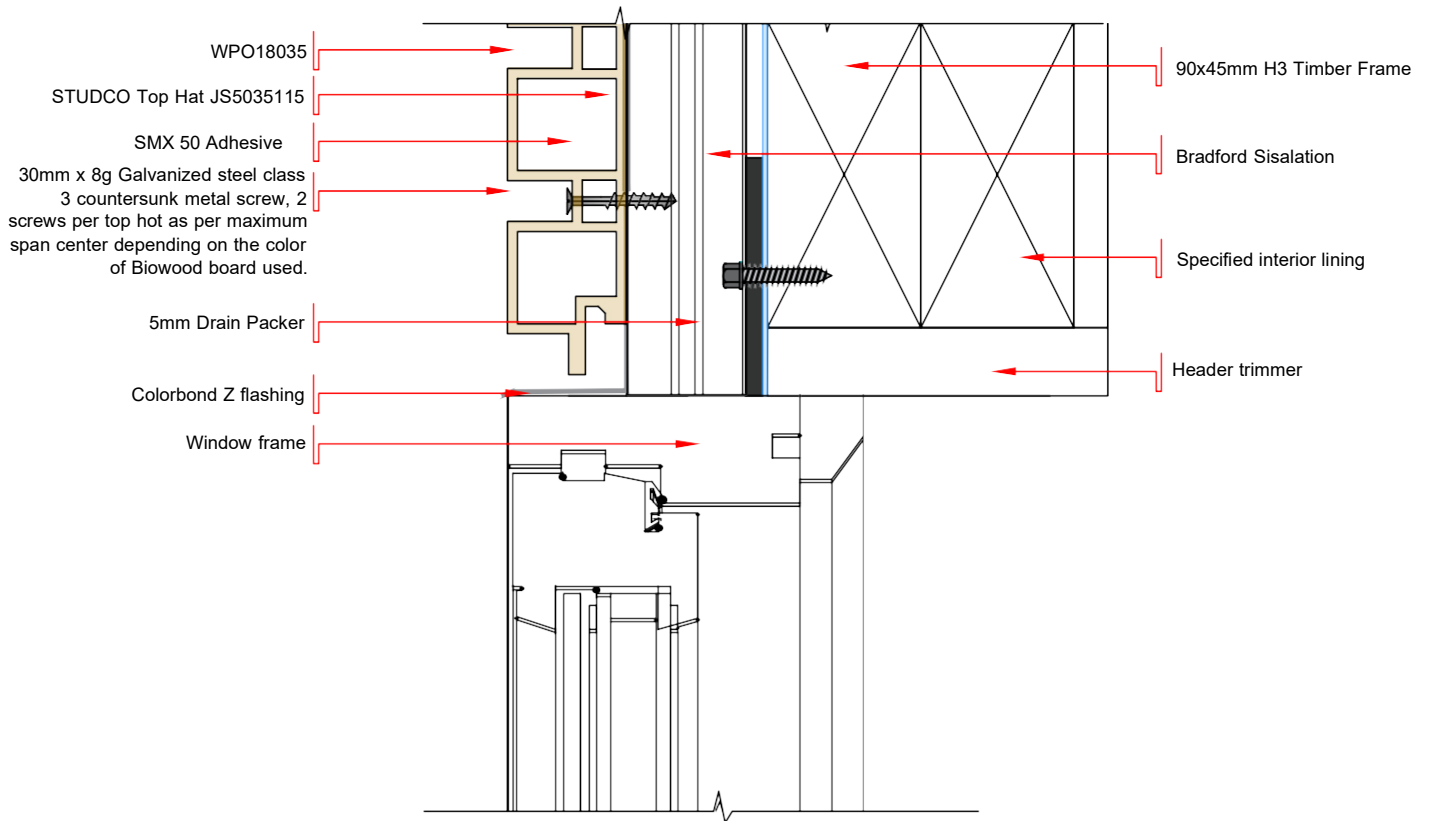

DWG - 06	SECTION VIEW OF WINDOW HEAD DETAIL OF HORIZONTAL LAID BIOWOOD CLADDING - WPO18035	SCALE 1:2.2 @ A4
----------	---	------------------

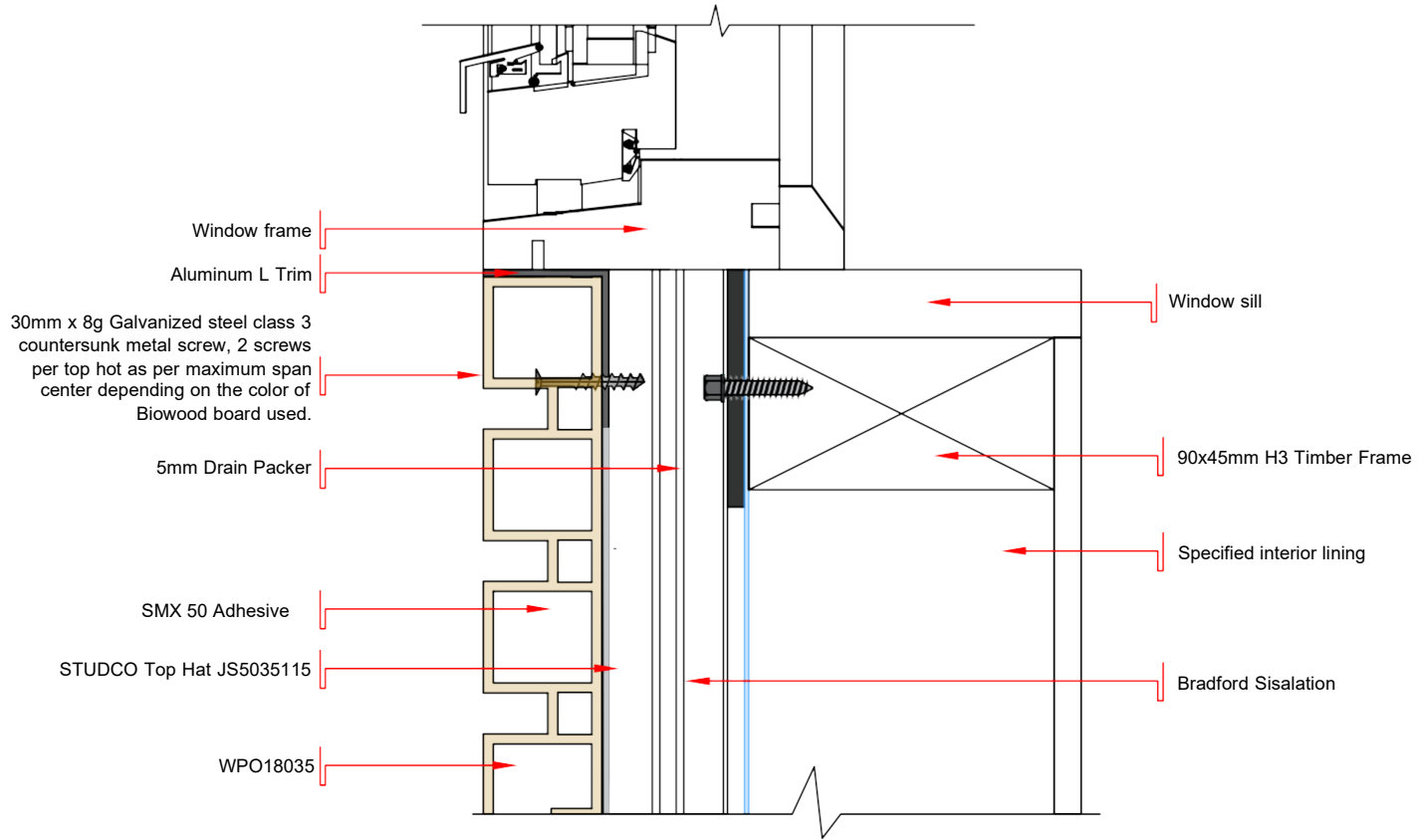

DWG - 07	SECTION VIEW OF WINDOW SILL DETAIL OF HORIZONTAL LAID BIOWOOD CLADDING - WPO18035	SCALE 1:2.2 @ A4
----------	---	------------------

THE BIOWOOD CASTELLATED PROFILE CLADDING WPO18035 HORIZONTAL INSTALLATION MANUAL  
 COPYRIGHT © GREEN RESOURCES MATERIAL AUSTRALIA PTY LTD ALL RIGHTS RESERVED Feb 1, 2026-VERSION 2.2

- THESE DRAWINGS MUST BE READ IN CONJUNCTION WITH THE LIST OF SPECIFIED / ACCEPTED PRODUCTS SUPPLIED WITH THE BIOWOOD CASTELLATED (WEATHERBOARD) & CASTELLATED PROFILE CLADDING AND SOFFIT SYSTEMS TECHNICAL MANUAL.
- SUBSTRATE TO BE PREPPED READY TO APPLY THE BIOWOOD CASTELLATED (WEATHERBOARD) & CASTELLATED PROFILE CLADDING TO. THIS MUST COMPLY WITH ALL RELEVANT STANDARDS AND REQUIREMENTS e.g. NZBC, GREEN RESOURCES MATERIALS AUSTRALIA PTY LTD AND OTHER PRODUCT DETAILS.



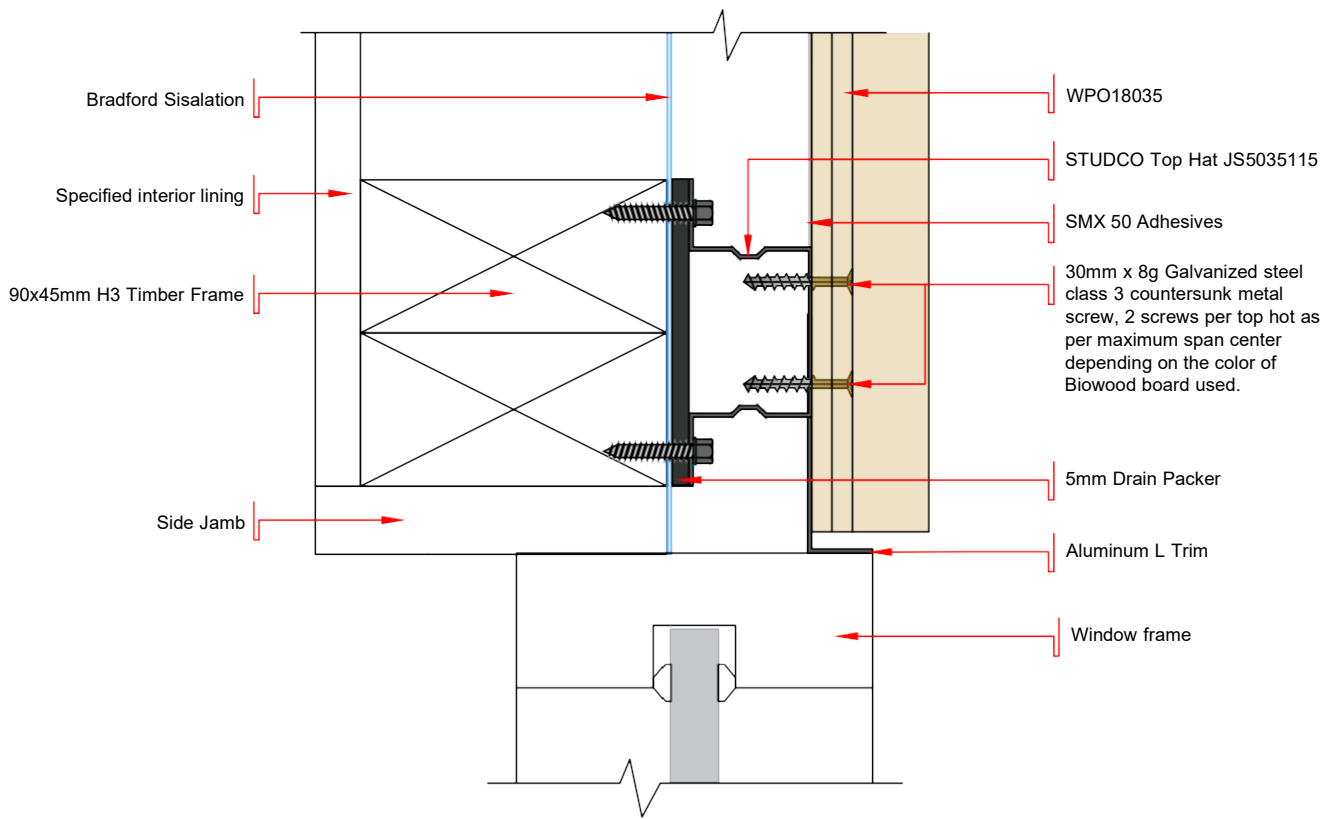

DWG - 08

PLAN VIEW OF WINDOW JAMB DETAIL OF HORIZONTAL LAID BIOWOOD CLADDING - WPO18035

SCALE 1:2.2 @ A4

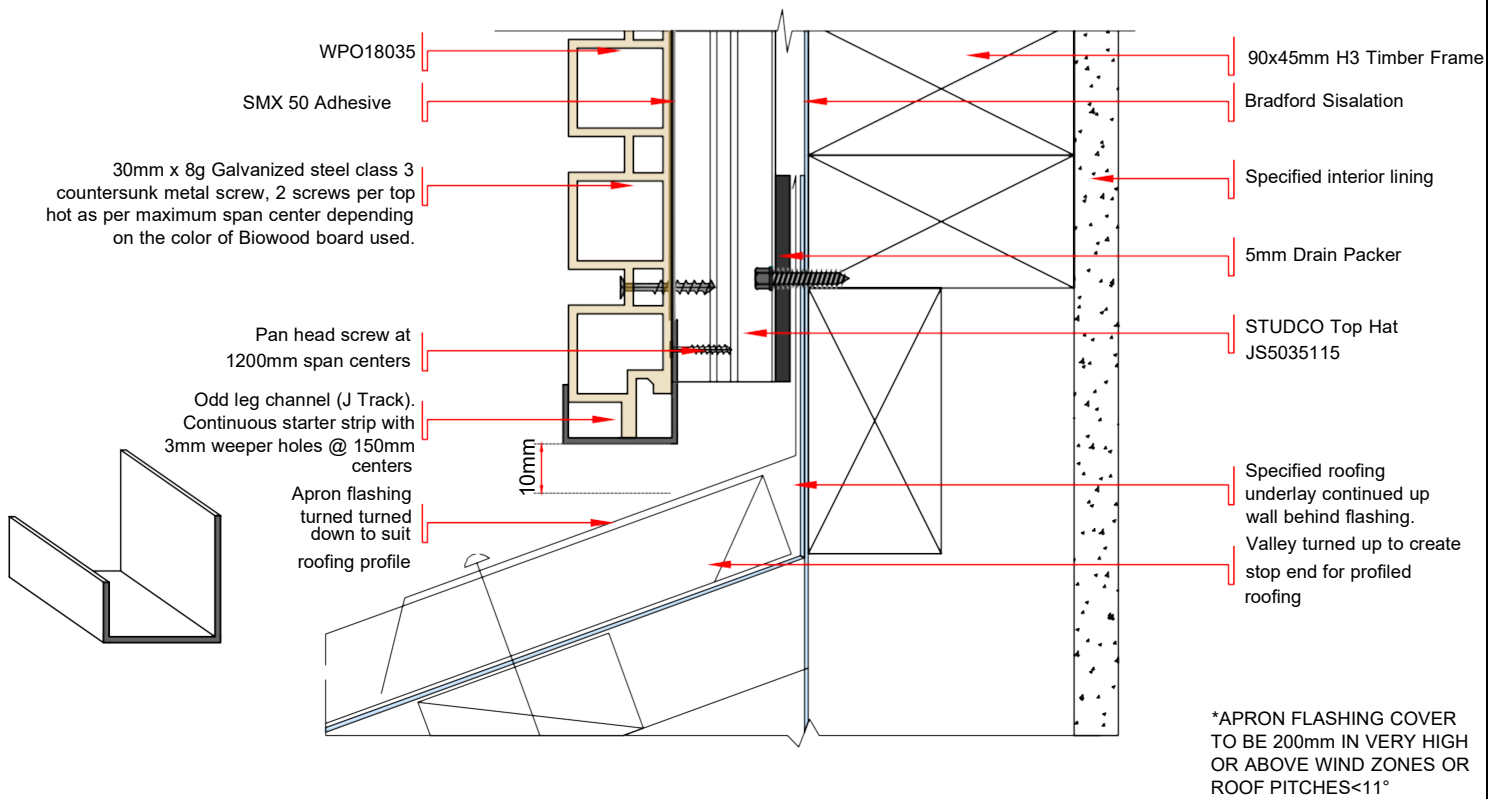

DWG - 09

SECTION VIEW OF TRANSVERSE APRON DETAIL OF HORIZONTAL LAID BIOWOOD CLADDING - WPO18035

SCALE 1:2.5 @ A4

THE BIOWOOD CASTELLATED PROFILE CLADDING WPO18035 HORIZONTAL INSTALLATION MANUAL  
 COPYRIGHT © GREEN RESOURCES MATERIAL AUSTRALIA PTY LTD ALL RIGHTS RESERVED Feb 1, 2026-VERSION 2.2

- THESE DRAWINGS MUST BE READ IN CONJUNCTION WITH THE LIST OF SPECIFIED / ACCEPTED PRODUCTS SUPPLIED WITH THE BIOWOOD CASTELLATED (WEATHERBOARD) & CASTELLATED PROFILE CLADDING AND SOFFIT SYSTEMS TECHNICAL MANUAL.
- SUBSTRATE TO BE PREPPED READY TO APPLY THE BIOWOOD CASTELLATED (WEATHERBOARD) & CASTELLATED PROFILE CLADDING TO. THIS MUST COMPLY WITH ALL RELEVANT STANDARDS AND REQUIREMENTS e.g. NZBC, GREEN RESOURCES MATERIALS AUSTRALIA PTY LTD AND OTHER PRODUCT DETAILS.



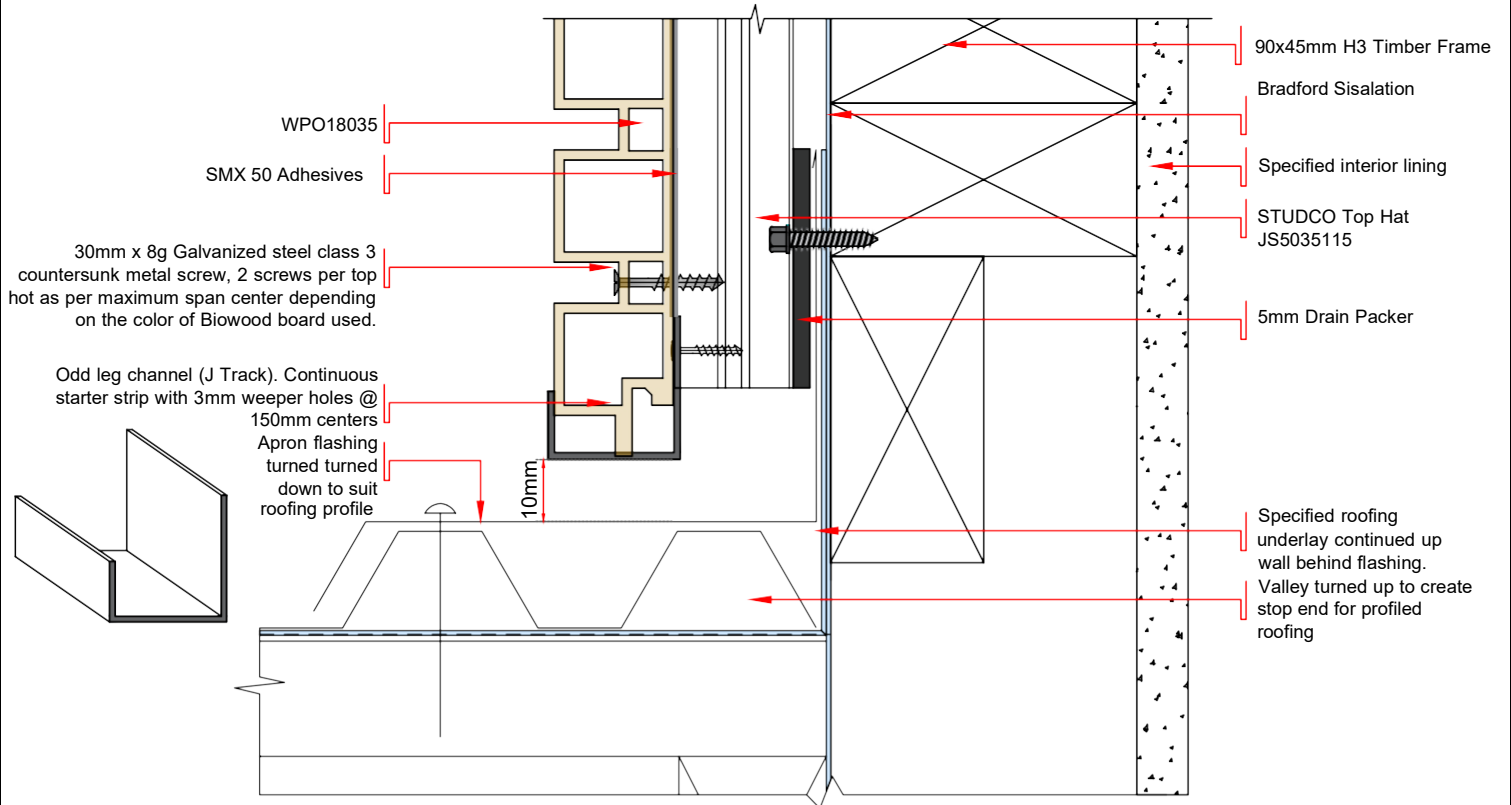

DWG - 10 SECTION VIEW OF PARALLEL APRON DETAIL OF HORIZONTAL LAID BIOWOOD CLADDING - WPO18035 SCALE 1:2.2 @ A4

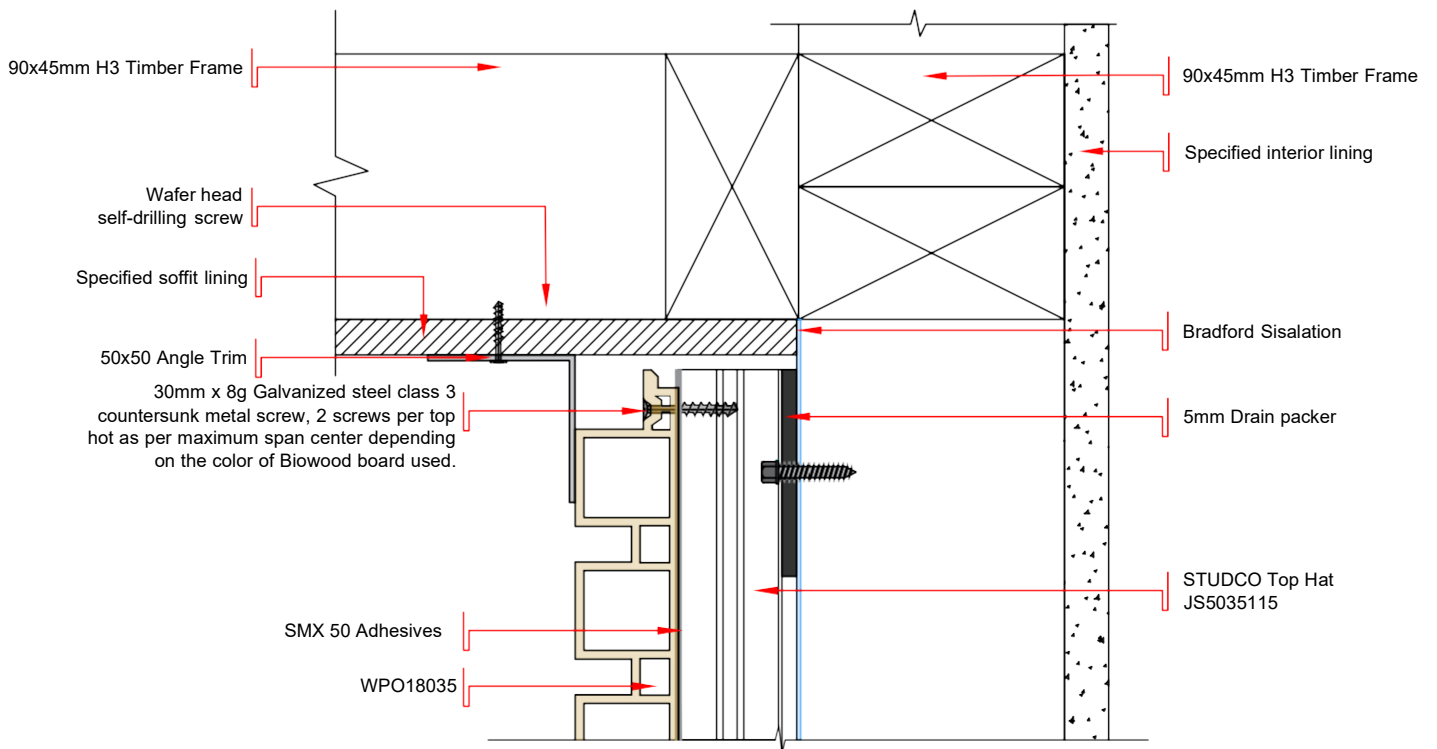

DWG - 11 SECTION VIEW OF CLADDING TO SOFFIT DETAIL OF HORIZONTAL LAID BIOWOOD CLADDING - WPO18035 SCALE 1:2.5 @ A4

THE BIOWOOD CASTELLATED PROFILE CLADDING WPO18035 HORIZONTAL INSTALLATION MANUAL  
 COPYRIGHT © GREEN RESOURCES MATERIAL AUSTRALIA PTY LTD ALL RIGHTS RESERVED Feb 1, 2026-VERSION 2.2

- THESE DRAWINGS MUST BE READ IN CONJUNCTION WITH THE LIST OF SPECIFIED / ACCEPTED PRODUCTS SUPPLIED WITH THE BIOWOOD CASTELLATED (WEATHERBOARD) & CASTELLATED PROFILE CLADDING AND SOFFIT SYSTEMS TECHNICAL MANUAL.
- SUBSTRATE TO BE PREPPED READY TO APPLY THE BIOWOOD CASTELLATED (WEATHERBOARD) & CASTELLATED PROFILE CLADDING TO. THIS MUST COMPLY WITH ALL RELEVANT STANDARDS AND REQUIREMENTS e.g. NZBC, GREEN RESOURCES MATERIALS AUSTRALIA PTY LTD AND OTHER PRODUCT DETAILS.



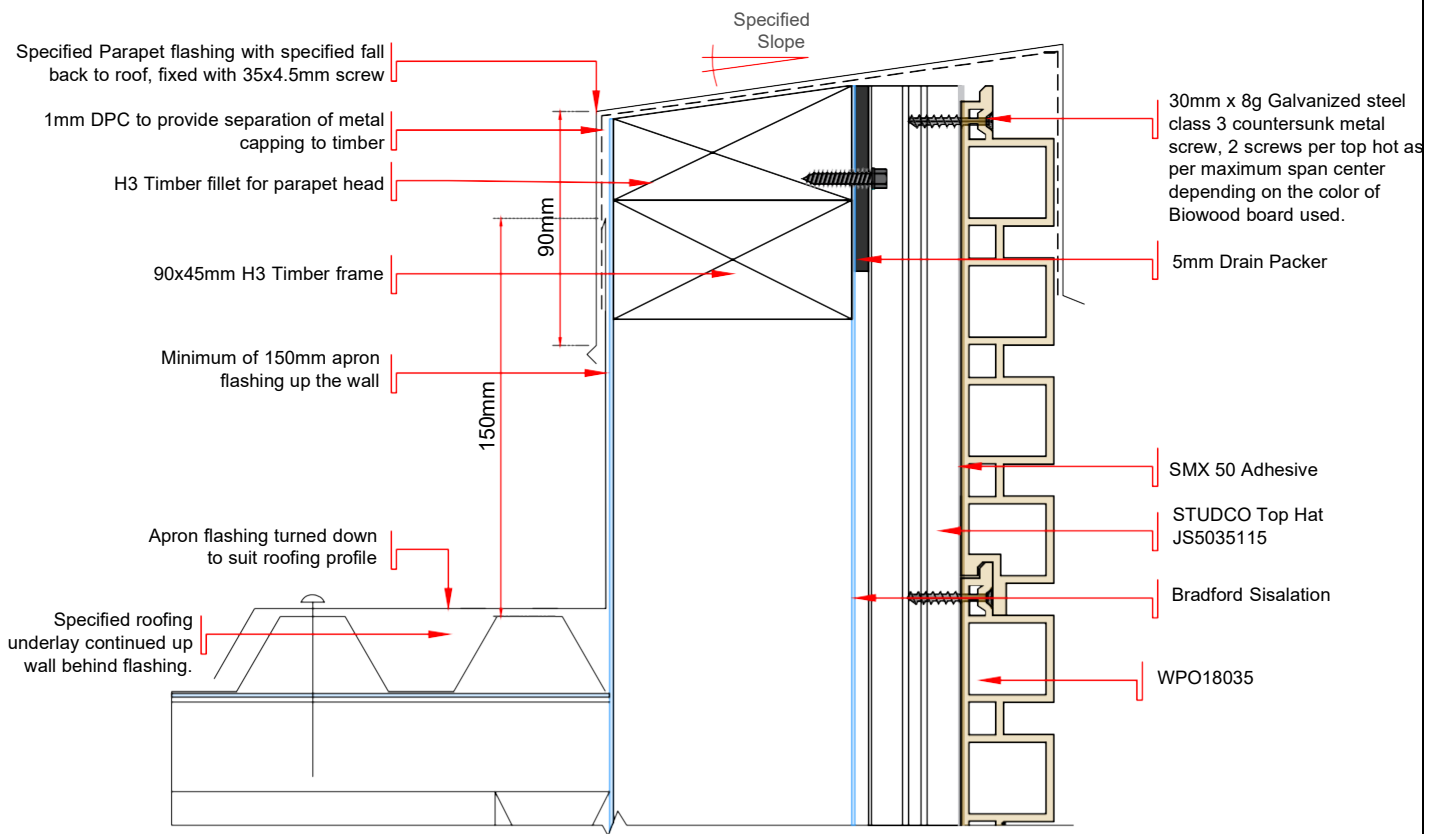

DWG - 12 SECTION VIEW OF PARAPET TO ROOF JUNCTION DETAIL OF HORIZONTAL LAID BIOWOOD CLADDING - WPO18035 SCALE 1:3 @ A4

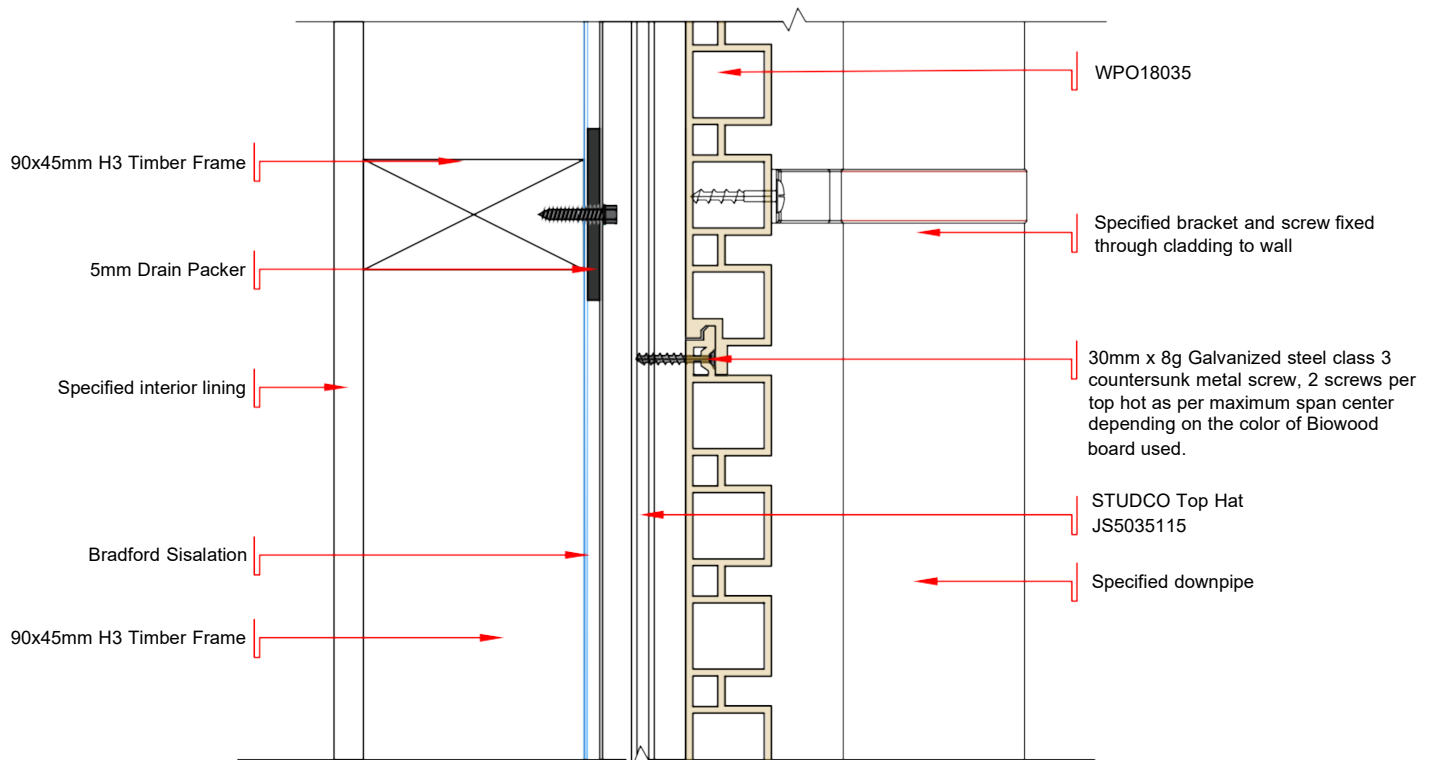

DWG - 13 SECTION VIEW OF DOWNPIPE FIXING DETAIL OF HORIZONTAL LAID BIOWOOD CLADDING - WPO18035 SCALE 1:3 @ A4

THE BIOWOOD CASTELLATED PROFILE CLADDING WPO18035 HORIZONTAL INSTALLATION MANUAL  
 COPYRIGHT © GREEN RESOURCES MATERIAL AUSTRALIA PTY LTD ALL RIGHTS RESERVED Feb 1, 2026-VERSION 2.2

- THESE DRAWINGS MUST BE READ IN CONJUNCTION WITH THE LIST OF SPECIFIED / ACCEPTED PRODUCTS SUPPLIED WITH THE BIOWOOD CASTELLATED (WEATHERBOARD) & CASTELLATED PROFILE CLADDING AND SOFFIT SYSTEMS TECHNICAL MANUAL.
- SUBSTRATE TO BE PREPPED READY TO APPLY THE BIOWOOD CASTELLATED (WEATHERBOARD) & CASTELLATED PROFILE CLADDING TO. THIS MUST COMPLY WITH ALL RELEVANT STANDARDS AND REQUIREMENTS e.g. NZBC, GREEN RESOURCES MATERIALS AUSTRALIA PTY LTD AND OTHER PRODUCT DETAILS.





## Option 1: Care and maintenance with Biowood facades & soffits

Biowood reconstituted wood composite architectural products are a sustainable timber alternative with added benefits such as durability and strength. Best of all, our product is low maintenance and environmentally friendly, meaning that you spend less time worrying about it and more time enjoying the benefits of your door.

Your door has been factory finished with a water based semitransparent stain in a matt sheen. This product has been formulated specially to give optimum performance on Biowood reconstituted wood composite. This high-performance finish offers long-term protection against Australia's harsh natural conditions and resists stain absorption and dirt settle, helping the surface stay clean and looking great. The finish is available in several pigmented natural timber colours formulated exclusively to complement the different Biowood timber tones.

### Maintenance of your Biowood Decking, Cladding and Ceiling

- Conduct a routine 12 monthly maintenance inspection to ensure any mechanical damage is repaired timeously.
- Best protection and ease of maintenance is ensured if the coating is recoated before deterioration of the coating and timber underneath occurs.
- First indication of the need for recoating will be observed as chalkiness or discoloration of the surface.
- To apply a maintenance coat to a surface which is in good condition, simply clean the surface with Intergrain UltraPrep™ Timber Cleaner and apply one coat of Intergrain- Enviropro Endure Deck Matt or Deck Stain Range Matt Finished (Refer to 2<sup>nd</sup> page with Biowood colours for Intergrain colour uv range)

### Surface Preparation

- Remove surface dirt by sweeping or washing down with water.
- Shake Intergrain® UltraPrep™ Timber Cleaner thoroughly. Mix ONE (1) part product to FOUR (4) parts waters in a plastic container.
- Apply Intergrain® UltraPrep™ Timber Cleaner mixture generously to the surface with a stiff bristle brush, broom or scouring pad. Clean complete sections at one time. Spot cleaning should be avoided to prevent patchy results.
- Leave mixture on the timber for 10-15 minutes. If necessary, apply more mixture to keep timber damp throughout this period. For best results Intergrain® UltraPrep™ Timber Cleaner should be applied to cool surfaces, out of direct sunlight, to avoid the cleaner drying on the surface.
- Rinse off thoroughly using maximum pressure from a garden hose or using a high-pressure water cleaner. A high-pressure water cleaner is recommended for large areas.

Allow surface to dry thoroughly.

### Handling and Storage:

Key points to be followed before and during the installation process:

- Store the material on a flat surface providing stable support on the whole surface, in a dry, clean area, protected from frost and direct sun light.
- Before starting the installation, carefully check the material and notify immediately of any manufacturing issues. **Complaints will not be accepted after installation.**
- Before starting the installation, check project's drawings (or shop drawings if provided) and the correspondence of the received material against the packing list.
- Acclimate the material in stock to the temperature of the jobsite for at least 48 hours prior to installation.
- The installation temperature must be higher than 0 °C.
- Do not cover the product with sheets made with non-breathable material (nylon, polyethylene, and similar materials). For this purpose, it is advisable to use breathable material such as painter felt sheets.
- The accumulation of electrostatic charges is a natural phenomenon commonly found in plastic materials, and under exceptional environmental conditions this may also occur in Biowood products.
- Profiles shall be handled with care to prevent damages. It is recommended to lift the profiles on the whole length during displacement and not make them slide on top of each other. Always use clean fabric gloves when handling profiles.
- Prevent the formation of dirt on and between profiles; in particular, make sure that mechanical processes are carried out on other materials,

near Biowood products, do not determine the accumulation of chips or dust of any kind. During the installation/assembly phase do not apply any label or sticker; if already applied, please remove immediately after installation. Immediately remove major stains such as paint, concrete or tar residues.

## **Application**

- Stir Intergrain® Enviropro Endure Deck Matt or Deck Stain Range Matt/Satin Finished thoroughly before and during use with a flat blade stirrer. Do not thin. If project requires more than one can of Intergrain® Enviropro Endure Deck Matt or Deck Stain Range Matt Finished, mix all cans together in one large container to achieve colour uniformity.
- Apply Intergrain® Enviropro Endure Deck Matt or Deck Stain Range Matt/Satin Finished using a quality brush, lambswool applicator, or spray (HVLP or airless). Do not apply by roller. If spraying, back-brush immediately after each section is coated to ensure a uniform finish.
- Do not overspread or apply thinly as insufficient film thickness will result in lap marks and compromise performance and durability.
- Coat no more than three boards at a time. Complete an entire length or continue until a natural break occurs.

## **DRY TIME - COAT IN ANY SEASON**

**Ideal Conditions** Temperature between 15 - 35°C and Humidity <85% Recoat **2 hours**.

**Cool Conditions** Temperature between 5 - 15°C and Humidity <85% Recoat **6 hours**.

*Do not apply to hot surfaces or in direct sunlight, as doing so will result in difficult application, poor adhesion, and blistering. Full curing 7 days.*

## **Coverage**

10 - 12 square meters per litre.

Refer to product label or datasheets for more information.

***For Biowood colours, the following colours from Intergrain range: Available only to GRM Australia or Biowood Distributors in each state in Australia & New Zealand.***

### **Enviropro Endure Deck *Satin* Finished (23% Sheen):**

Spotted Gum and Deep Walnut: Natural

### **Enviropro Endure Deck *Stain Satin* Finished (23% Sheen):**

Black Japan:	Charcoal
Natural Oak:	Oak
Weather Wood:	Grey
Driftwood:	Light Grey
Merbau:	Merbau
Caoba:	Rich Chocolate

## Option 2: Care and maintenance with Biowood garage door, facades & soffits

### MAINTENANCE EXTERIOR

### MAINTENANCE PROCEDURE

Biowood reconstituted wood composite architectural products are a sustainable timber alternative with added benefits such as durability and strength. Best of all, our product is low maintenance and environmentally friendly meaning that you spend less time worrying about it and more time enjoying the benefits of your cladding, garage doors, door entries and soffits.

Biowood has been factory finished with a water based semitransparent stain in a satin sheen. This product has been formulated specially to give optimum performance on Biowood reconstituted wood composite. This high-performance finish offers long-term protection against Australia's harsh natural conditions and resists stain absorption and dirt settle, helping the surface stay clean and looking great. The finish is available in several pigmented natural timber colours formulated exclusively to complement the different Biowood timber tones.

#### **Introduction.**

Bioseal UV Seal exterior products combine various substrates with the unique Biowood technology to produce low maintenance coatings in most environments. Bioseal UV Seal has been tested for use on Biowood composite timber and has shown excellent adhesion and performance properties. Bioseal UV Seal is our recommended coating for all Biowood exterior composite timber. To ensure optimum decorative life from Bioseal UV Seal products the following procedure is recommended.

#### **PROCEDURE**

#### **Annual Cyclic Maintenance.**

Biowood Bioseal when used as exterior coating will accumulate atmospheric fall-out which may include soot and residual acids in industrial environments, automobile combustion contamination, gum spotting, lichen and organic matter from neighboring vegetation, bird fouling, etc.

The Biowood Bioseal surface is finished with a smooth chemical-resistant glaze and most of the above contaminants will be washed off it when exposed to rain.

In the event of unacceptable disfigurement from any source the original surface of Biowood Bioseal will be restored by annual water blasting or washing with cloth and soapy water followed by hosing down every 3 months, depending on service &/or environment conditions.

The above treatment should be carried out in such a way as to leave the surface uniform in appearance.

No other cyclic maintenance is needed or recommended.

#### **Mechanical Damage Repair.**

Scratch damage can usually be repaired simply by application of the topcoat colour (available from the manufacturer) using a fine camel hairbrush.

Major damage needs expert attention, and the suppliers should be consulted with a description of the extent of the damage in view of the most appropriate option being selected.

The options are : -

- (a) repair on-site
- (b) complete respray or panel replacement

## MAINTENANCE INTERIOR

### MAINTENANCE PROCEDURE

#### **Introduction.**

Interior designates modular interior wall or ceiling paneling factory-finished in highly durable Biowood Bioseal.

#### **CARE**

##### **General Regular Cleaning:**

This is best carried out with a sponge or a soft cloth and any household cleaning detergents or solvents.

**Abrasive cleaning agents must not be used.**

##### **Polishing:**

The product is suitable for polishing with soft cloth if required.

##### **Graffiti Removal:**

Pressure pack (i.e., paint) damage is usually easily removed by wiping with a mineral turpentine saturated rag within 48 hours of application.

Felt tipped marker damage should be removed using methylated spirits – again within 48 hours.

##### **Mechanical Damage:**

Should the panels be physically scored, chipped, or scraped in any way please consult the manufacturer for the best method of repair / replacement.

Scratch damage can usually be repaired simply by application of the topcoat (available from the manufacturer) using a fine camel hairbrush.

##### **Coverage**

6 - 8 square meters per litre.

Refer to product label or datasheets for more information.

***For Biowood colours, the following colours from Bioseal UV Seal range: Available only to GRM Australia or Biowood Distributors in each state in Australia & New Zealand.***

#### **Bioseal UV Seal Matt Finished (10% Sheen):**

Spotted Gum and Deep Walnut:	Bioseal Brown
Black Japan:	Bioseal Black
Charred Wood:	Bioseal Monument
Western Red Cedar:	Bioseal Clear
Natural Oak:	Bioseal Clear
Weather Wood:	Bioseal Clear
Driftwood:	Bioseal Clear
Lexicon White:	Bioseal Lexicon White
Surf mist:	Bioseal Surf mist

#### ***DISCLAIMER:***

*Since the use and application of this product is beyond our control, we cannot be held responsible for product field performance.*

*The information represented above is the result of our considerable experience with this product but is not to be construed as a performance warranty.*

# Annexure 1

## Biowood Bioseal UV Seal Warranty Details Document

### 1. Schedule of liability

The product lifespan of Biowood Bioseal UV Seal is dependent on both the degree of weathering and severity of UV exposure (i.e., location in Australia). When applied and maintained in strict accordance with the terms and conditions of this Warranty, Biowood Bioseal will not peel, blister, or flake for the period detailed in the tables below.

Coating requirement (coats)	2
Coating requirement (coats)	3

Vertical surfaces*	Light	Average	Severe
Fully sheltered	6 years	5 years	4 years
Partly sheltered	5 years	4 years	3 years
Unsheltered	4 years	3 years	2 years

Horizontal surfaces*	Light	Average	Severe
Fully sheltered	5 years	4 years	3 years
Partly sheltered	4 years	3 years	2 years
Unsheltered	3 years	2 years	12 months

\*See item 3 of this annexure for definitions.

### 2. Inspection & Touch Up

The coating system must be inspected regularly in the presence of Biowood Representative and any minor damage touched up at these stated intervals to maintain the Warranty.

	Inspect every 12 months and touch up any minor damage
	Inspect every 6 months and touch up any minor damage

To touch up any minor damage, clean all affected areas and apply two (2) coats of coating system originally used, in the original colour to the affected area, making sure to feather the edges to blend into the existing coating.

3. Definitions - Degree of weathering

Fully sheltered	Building offers complete protection from a solid opaque cover such as under a roof overhang, AND Is not exposed to direct sunlight from any direction.
Partly sheltered	Building offers partial protection from a solid opaque cover, OR Complete or partial protection from a transparent cover through which light is transmitted, such as glass or laser lite.
Unsheltered	Building offers no protection to the coating.

Severity of UV exposure

Severe	All areas with very high and extreme UV indexes.	
Average	All areas with high UV indexes OR Moderate UV indexes within 2km of the coast.	
Light	All moderate to low UV indexes 2km + away from the coast.	

Reference: UV Exposure in Australia

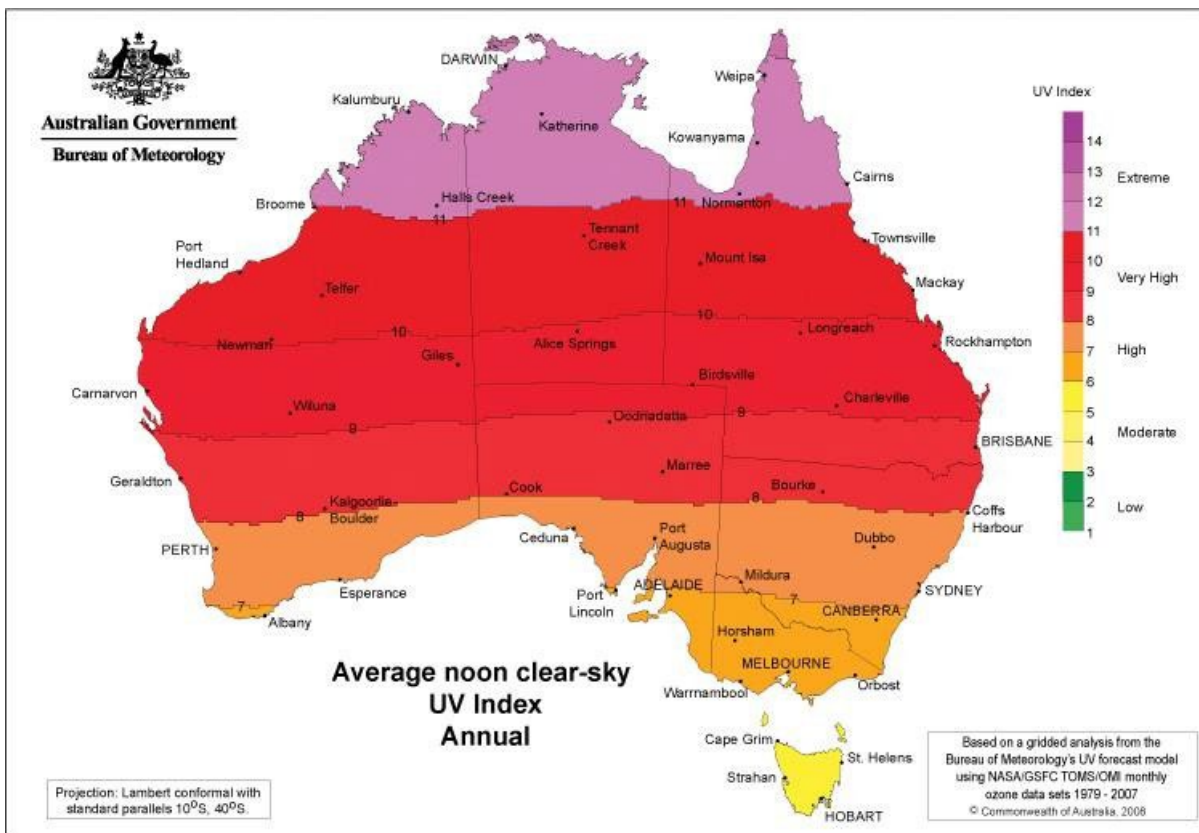

Sourced from Bureau of Meteorology, [http://www.bom.gov.au/jsp/ncc/climate\\_averages/uv-index/index.jsp](http://www.bom.gov.au/jsp/ncc/climate_averages/uv-index/index.jsp)  
 These maps show the average annual, monthly, and seasonal values of the UV Index over Australia for the period 1979-2007 under cloud-free conditions at local noon, when the sun is at its highest. These values are also representative of the values expected between 11 am and 1 pm local time (12 pm and 2 pm daylight saving time) under clear skies.



## **Green Resources Material Australia Pty Ltd**

Unit 2, 74-80 Helen Street Sefton, Australia NSW2162

p. +61 2 9644 6766

e. [inq@grmaustralia.com.au](mailto:inq@grmaustralia.com.au)

[www.grmaustralia.com.au](http://www.grmaustralia.com.au)